

Carbon Neutral Solution for Marine

Carbon Capture, Utilization and Storage
& Fuel Supply System
& Hydrogen Generation System

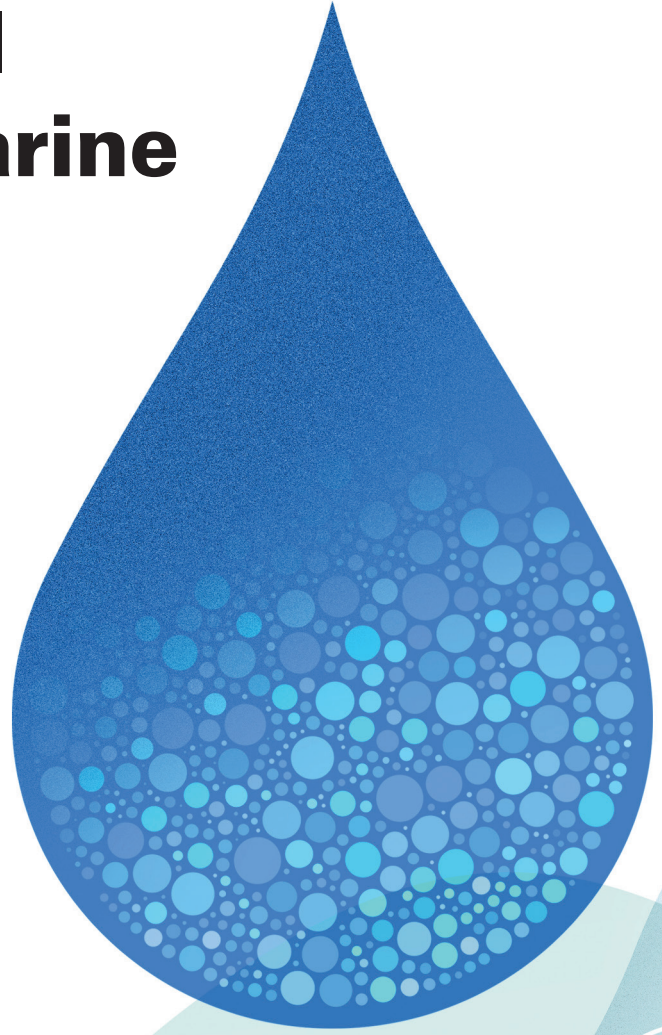

KOR

PANASIA

친환경 솔루션으로 미래를 향하는 기업! 파나시아

파나시아는 지구와 함께 공존하는 미래를 만들기 위해 앞장서는 친환경 에너지 솔루션 기업입니다.

대기환경분야부터 수질환경분야 그리고 수소사업분야까지, 자연의 기준에서 자연에게 인정받는 기술을 만들기 위해 파나시아의 도전은 멈추지 않습니다.

파나시아의 모든 제품은 ICT 기술을 기반으로 제품의 기획부터 설계, 생산, 서비스까지 모든 과정을 통합한 '스마트 파나시아'만의 시스템으로 기술이 스스로 학습하며 진화하는 더욱 고도화된 우수한 품질의 제품을 제공합니다.

파나시아는 핵심 기술과 축적된 경험들을 통하여 다양한 환경분야에서 기술력으로 맞서는 글로벌 리더로 도약하였습니다.



수질환경분야 Water Quality Environment



수처리장치



수위제어계측장비



세정수처리장치
(Chemical/Membrane)

대기환경분야 Air Quality Environment



황산화물저감장치



질소산화물저감장치



엔진배기가스재순환장치
(iCER)

수소사업분야 Hydrogen Business



수소추출기



탄소포집·저장장치
(CCS/OCCS)

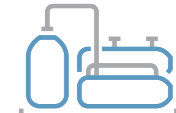

연료공급장치
(LNG/Ammonia/Methanol)



CARBON-NEUTRAL SOLUTION CATEGORY FOR SHIP

Hydrogen Generation System
& Carbon Capture and Storage System

- CARBON CAPTURE AND STORAGE SYSTEM
- AMMONIA CRACKING HYDROGEN GENERATION SYSTEM
- NATURAL GAS REFORMING HYDROGEN GENERATION SYSTEM
- MRO SERVICE

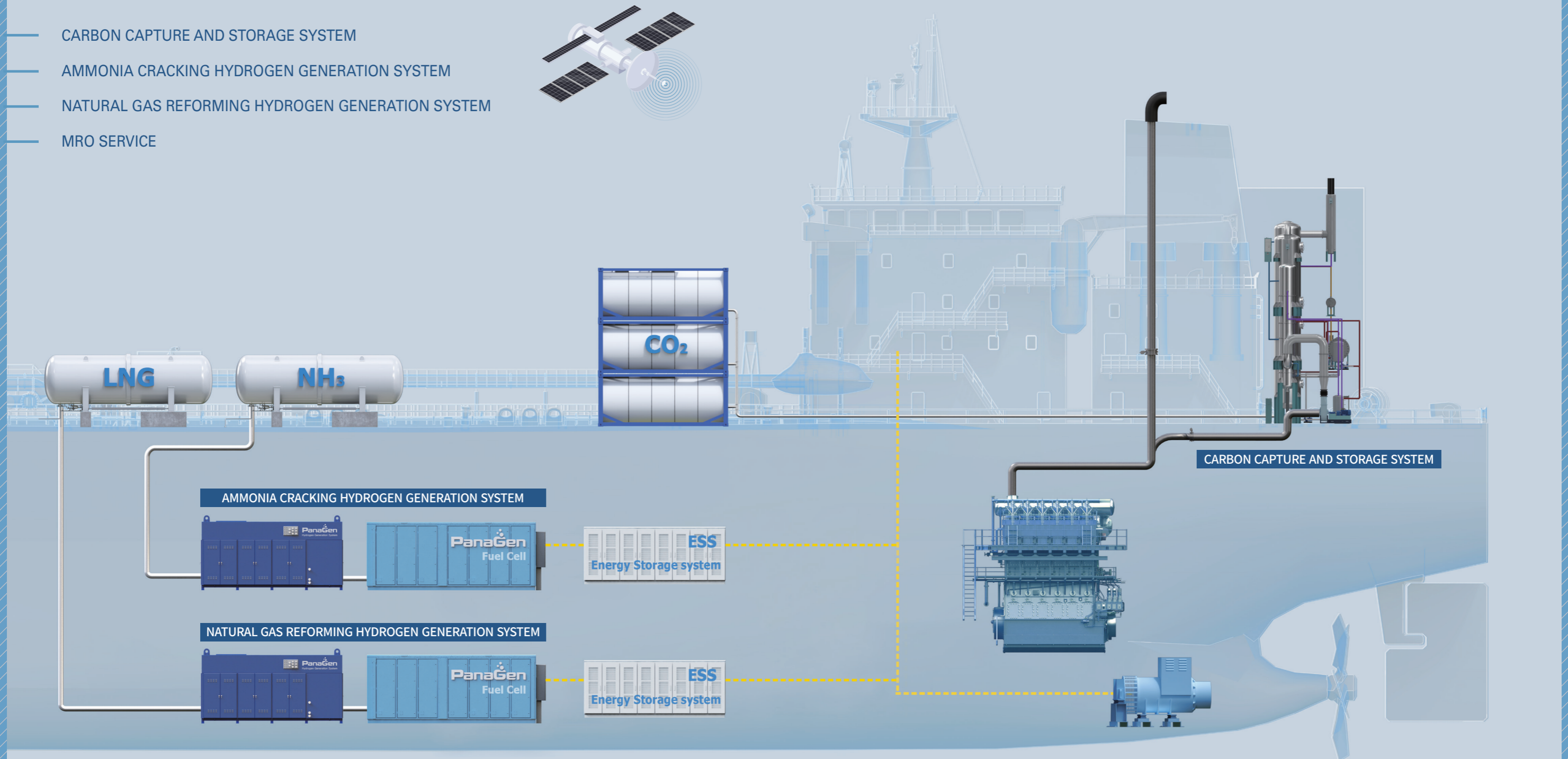

Strengthened IMO strategy on GHG reductions

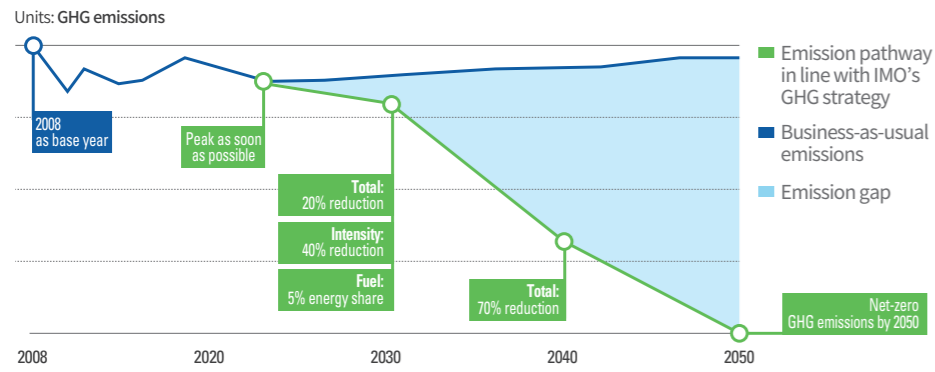

Total: Well-to-wake GHG emissions; Intensity: CO₂ emitted per transport work; Fuel: Uptake of zero or near-zero GHG technologies, fuels and/or energy sources

CII Carbon Intensity Indicator

탄소집약도 등급제

- 탄소집약도 등급제(Carbon Intensity Rating)는 5,000GT 이상 국제 항해 중사 선박을 대상으로 함
- 탄소집약도 지표(CII)는 선박 운항 데이터를 기반으로 선박의 효율성을 정량화 한 값을 의미
- 연간 CII 요구값 대비 연간 CII 달성값이 향상된 정도에 따라서 A부터 E까지 등급을 부여하는 규제

$$CII = \frac{\text{Annual fuel consumption} \cdot CO_2 \text{ factor}}{\text{Annual distance travelled} \cdot Capacity} \cdot \text{Correction factors}$$

To be developed

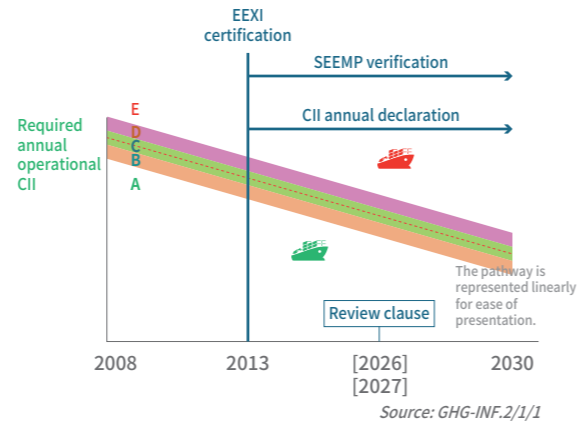

Source: GHG-INF.2/1/1

GHG Reduction Technologies

Category	Technology	Details	GHG Reduction(%)
Ship energy efficiency improvement	Resistance efficiency	Ship design optimization	10-15
		Resistance reduction technology	2-7
		Structure lightening	0-10
	Propulsion efficiency	High efficiency propulsion development	0-20
		ESD Development	0-7
Clean, alternative and energy	Alternative fuel(1) low carbon fuel	LNG, LPG, CNG	20-30
		Hydrogen	0-100
	Alternative fuel(2) zero carbon fuel	Methanol	20-100
		Ammonia	20-100
		Bio	20-100
	Alternative fuel(3) non fossil fuel	Electricity(Battery)	0-100
		Fuelcell(Hydrogen)	0-100
		Wind power	1-32
		Solar power	0-12
		Nuclear power	0-100
Operating efficiency	Navigation optimization	Voyage and speed optimization	0-60
	Fleet optimization	Cargo volume optimization	0-30
	Operating optimization	Vessel-port interface, AMP	0-5
	Onboard CCS	Post combustion	0-60
	Ship operating system	Internal energy efficiency improvement, waste heat reclaimer	2-7

The new FuelEU Maritime regulation (Fit For 55 by the European Union)

2025년부터 FuelEU Maritime 적용 대상 선박(총 5,000톤 이상의 선박)은 선박 온실가스 집약도(GHG Intensity)의 제한기준을 만족하여야 함

GHG Intensity 계산은 에너지를 사용하기 이전 단계인 생산, 이송 및 배분(Well-to-tank)에 대한 온실가스 집약도 및 에너지의 사용단계(Tank-to-wake)에 대한 온실가스 집약도를 더하여 Well-to-wake의 전체 온실가스 집약도를 계산함

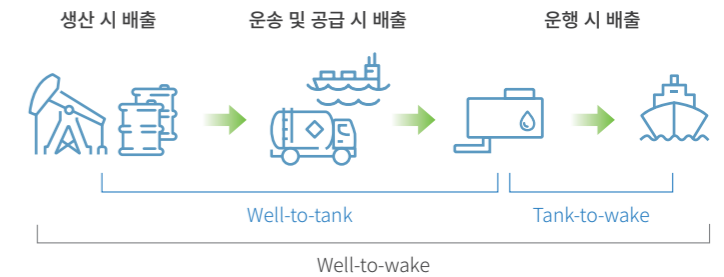

Emission Factors status by organizations

Fuel consumption	×	Emission Factors (T-W or W-W)	=	Carbon emission
Category		Tank to Wake	Well to Wake	
기타 분야 (IPCC National GHG Inventory)		•		
항공	EU (EU-ETS)	•		
	CORSIA*		•	
해운	EU (Fuel EU Maritime)		•	
	EU (EU-ETS)	•		
	IMO	•		Under discussion

* CORSIA : Carbon Offsetting and Reduction Scheme for International Aviation

Fuel's GHG Intensity

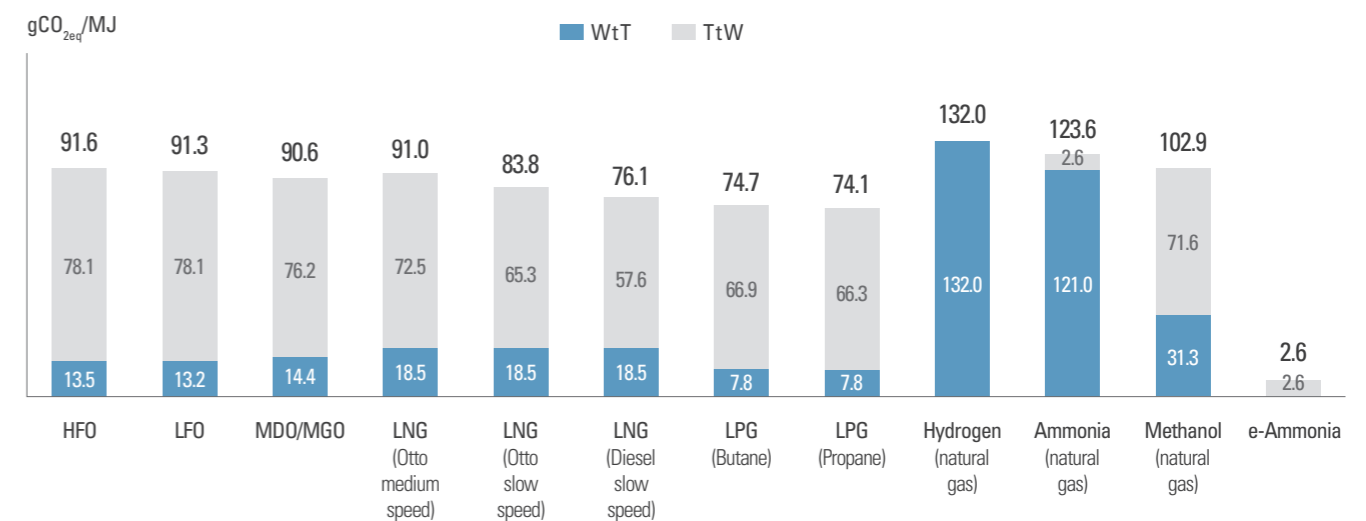

(Source: Prepared by ClassNK based on the emissions factors listed in the FuelEU Maritime Regulations, etc.)

Onboard Carbon Capture And Storage System



Pan-OCCS™



Pan-OCCS™

파나시아의 선박용 탄소 포집·저장 장치 Pan-OCCS™(Onboard Carbon Capture And Storage System)는 화석연료에서 발생하는 CO₂를 대기중으로 배출하기 전에 포집·저장 해주는 장치입니다.

TECHNOLOGY

CCS Key Components

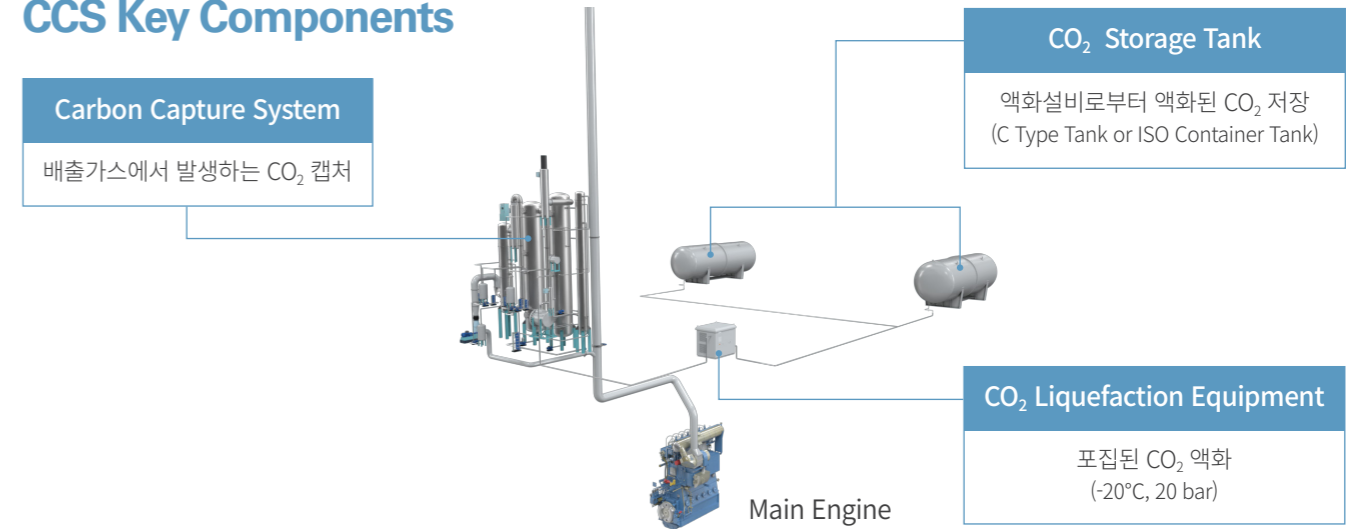

Schematic Diagram of Carbon Capture Process

1 Pre-treatment of flue gas

Flue Gas는 Quenching Tower에서 냉각과 Particle 및 황산화물의 제거된 후 Intake Fan을 통해 가압되어 Absorber 탑으로 이송됩니다.

2 CO₂ absorption

냉각된 가스는 화학용제와 Absorber 내에서 접촉하여 CO₂가 선택적으로 흡수됩니다. 효율적인 물질전달과 Tower의 크기를 최소화하기 위해 고성능 Packing과 적절한 내부배치가 요구됩니다.

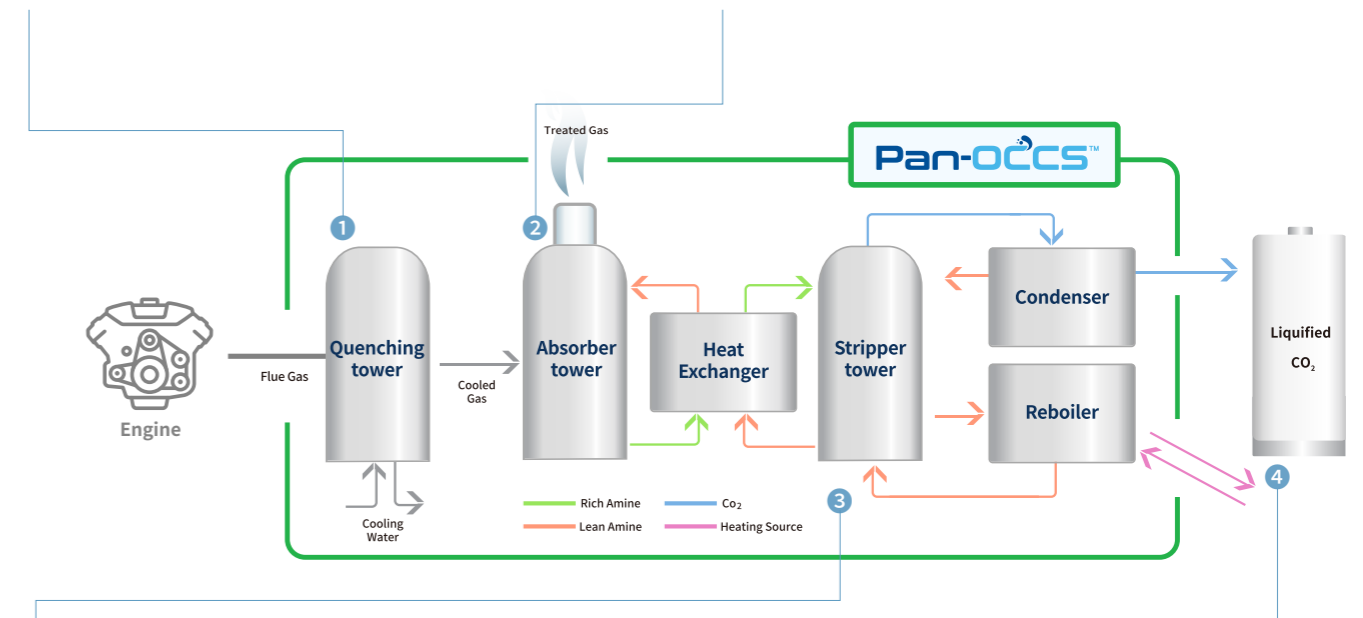

3 Regeneration

CO₂가 흡수된 용제는 Stripper tower로 이송되어 Reboiler의 고온증기에 의해 용제에서 CO₂가 탈거되고 냉각기에서 물과 CO₂로 분리되어 물은 Stripper로 회수하고 CO₂는 액화공정으로 이송됩니다.

4 Liquefaction & storage

저장용기 및 판매 요구사항을 충족하기 위해서 가압 및 냉각하여 액화시킵니다.

CCS Test Barge Facility



파나시아 '선박 이산화탄소 포집기술 OCCS (Onboard Carbon Capture and Storage System)' 국내 최초 한국 선급 (KR) 기본승인(AIP) 획득

Intake Gas Property

Item	Description
Mass Gas Flowrate	323 kg/hr
Flue Gas Flowrate (at 40°C)	250 Nm ³ /hr
Fuel Type	HSFO (3.5%)

General Specification

Item	Description
Capturing Level	90%
Pressure Drop	Under 500mmAq
Captured CO ₂	0.6 Ton/day

Composition of Exh. Gas

Ingredient	Composition (Vol%)	Flowrate (L/h)	Flowrate (L/h@40°C)	Mol	Weight (kg)	Mass Fraction
N ₂	75.6	189000	216692	8437.5	236.42	73.2%
O ₂	12.6	31500	36115	1406.3	45.00	13.9%
Ar	0.8	2000	2293	89.3	3.57	1.1%
H ₂ O	5.5	13750	15765	613.8	11.06	3.4%
CO ₂	5.5	13750	15765	613.8	27.02	8.4%
Summary	100	250000	286630	11161	323	100.0%

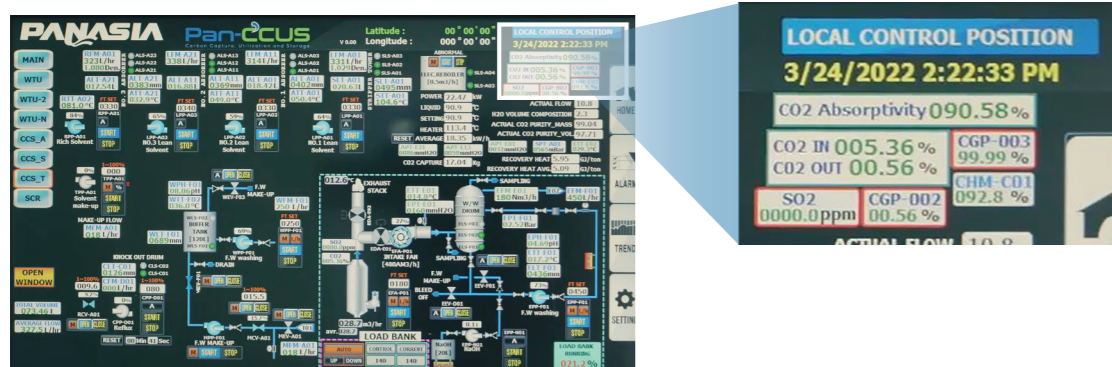

Feature

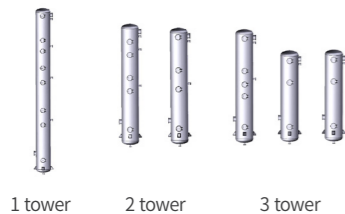

선박 높이에 따른 단타워

운영 및 유지보수 편리



다양한 Solvent 검증

여러 기후조건에 유연한 대응 가능



Full Automation (HMI 활용)

MSCS 연계 및 HMI로 손쉬운 관리

*MSCS: Marine Satellite Control System

Feasibility Study

Study Process

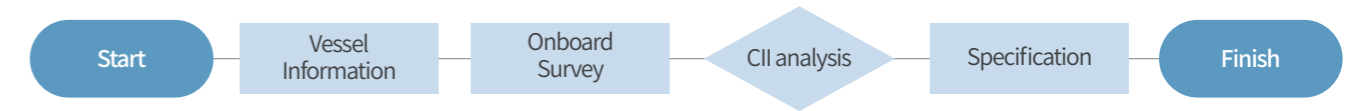

CII Calculation

선박의 정보를 통해 CII 계산.
선박의 목표운항기간을 고려하여 CII시나리오 및 CCS 설치플랜을 제공합니다.

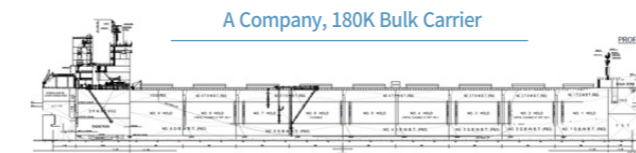

CIIR	2023	2024	2025	2026	2027	2028	2029	2030
2.56	2.43	2.38	2.33	2.28	2.21	2.14	2.07	2.00

Vessel Type	Bulk Carrier
Vessel Size	179,147 (DWT)
Fuel Type	HSFO, MGO
Annual Fuel Consumption	Average 9,144 MT
Target Ship Speed	15.3 knots
CO ₂ Emission	3.23 t/hr
1 Cycle Voyage Period	20 Day
Annual Voyage Distance	Average 51,600 Nm
Vessel's Target Life Time	2030

CII Analysis

Type	Size	DWT	Reduction Rate	CO ₂ -t/y	Reduction (CO ₂ -t/hr)	CII _A	CII _E	CII(AER) Scenario(~2030)									
								2023	2024	2025	2026	2027	2028	2029	2030		
BC	Cape	179,147	Base	28,325	0.00	2.86	2.563	D	E	E	E	E	E	E	E	E	
			5%	27,133	0.21	2.74		D	D	D	E	E	E	E	E		
			10%	25,941	0.41	2.62		D	D	D	D	E	E	E	E		
			15%	24,750	0.62	2.50		C	C	D	D	D	E	E			
			20%	23,558	0.83	2.38		C	C	C	D	D	D	E			
			25%	22,366	1.04	2.26		B	C	C	C	C	D	D			
			30%	21,175	1.24	2.14		B	B	B	B	C	C	D			
			35%	19,983	1.45	2.02		A	A	B	B	B	C	C			

*선박의 CII 등급이 단일 연도 E등급 또는 3년 연속 D등급인 경우, CII 허용값 달성을 위한 시정조치계획이 포함된 SEEMP Part III를 개발하여, 주관청 또는 인정기관의 승인을 받아야함.

Components Concept

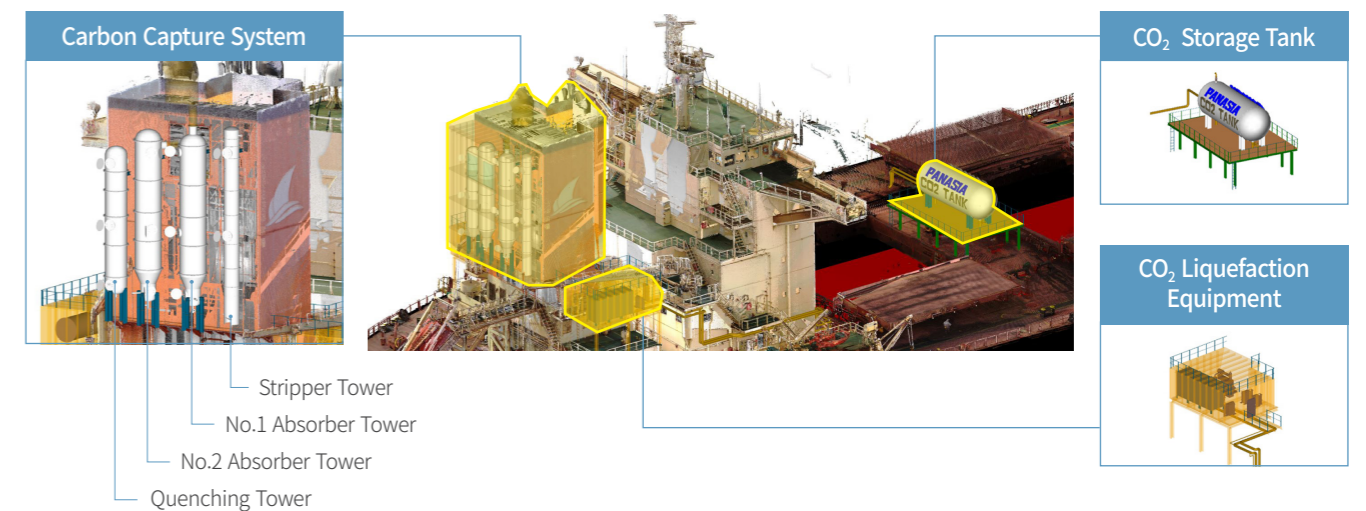

Fuel Supply System

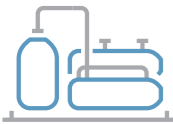

파나시아의 연료공급장치는 선박해양 환경규제에 따라 LNG, 암모니아, 메탄올과 같은 대체연료를 기화하여 엔진 및 보일러에 공급하는 장치입니다.

- LNG Fuel Supply System
- Methanol Fuel Supply System
- Ammonia Fuel Supply System

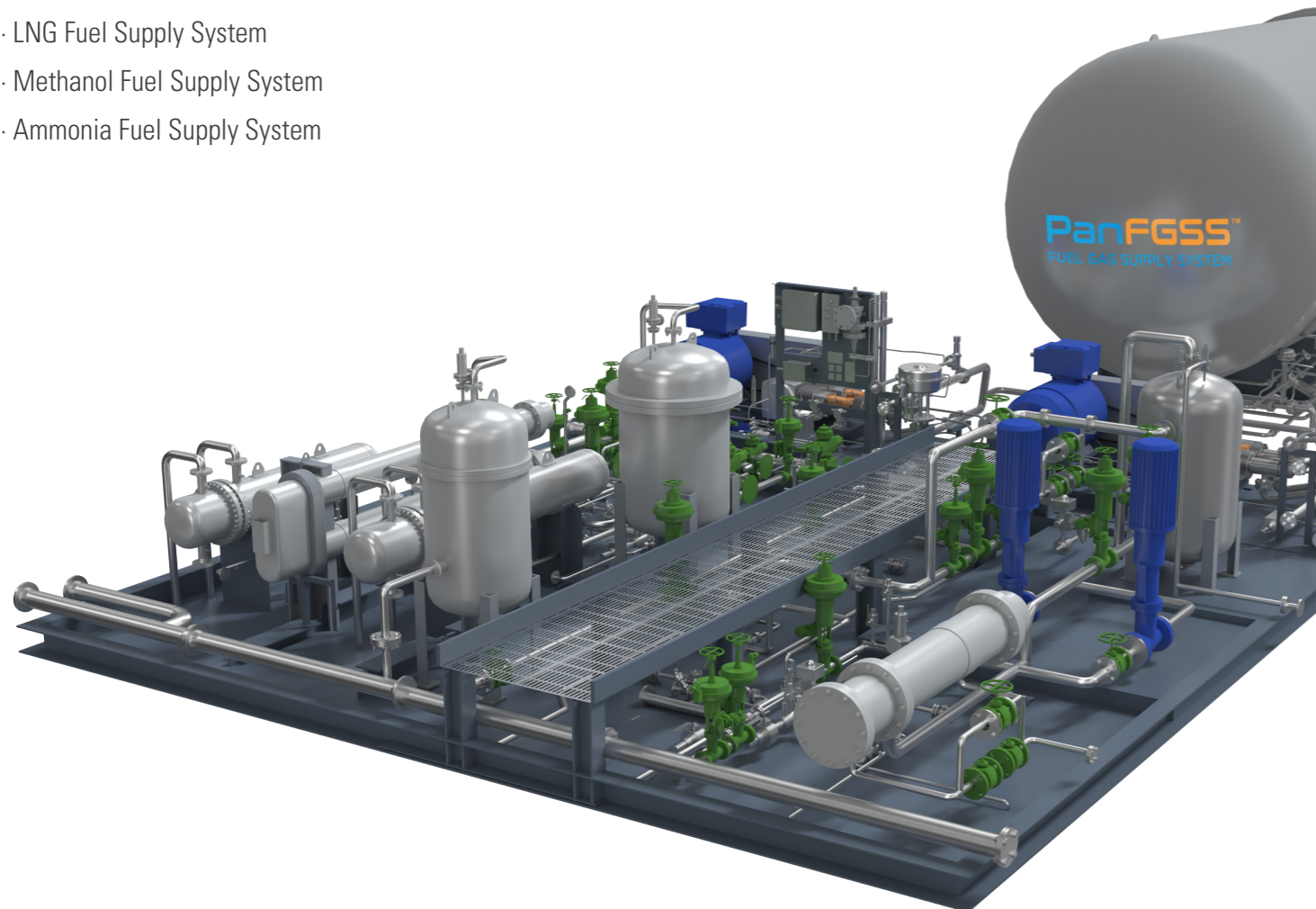

LNG Fuel Supply System

PanFGSS™

LNG Fuel Supply System은 LNG(Liquefied Natural Gas)를 선박의 연료로 사용하는 것을 말합니다.
엔진 모델에 따라 HP(고압) & LP(저압) Type으로 구분합니다.

1. HP/LP Type

— Design Data

- **HP Pump** Dis. Press. 300 bar reciprocating pump X 2 sets
- **LNG Feed Pump** Dis. Press 12 bar submersible centrifugal type pump X 2 sets
- **LP Vaporizer** Temp : -163°C → 45°C (Cold side)
- **HP Vaporizer** Temp : -163°C → 45°C (Cold side)
- **Glycol Skid** Glycol Water (Water 50 : Glycol 50)
Glycol Water Pump : Vertical Inline Centrifugal type X 2 sets
Heat Exchanger : Shell&Tube or Equivalent
Glycol Water Tank : abt. 0.5 m³
- **LNG Storage Tank** IMO Type-C Single Shell Tank
IMO Type-C Double Shell Tank
IMO Type-C Lattice Tank
Material 9% Nickel Steel or Equivalent

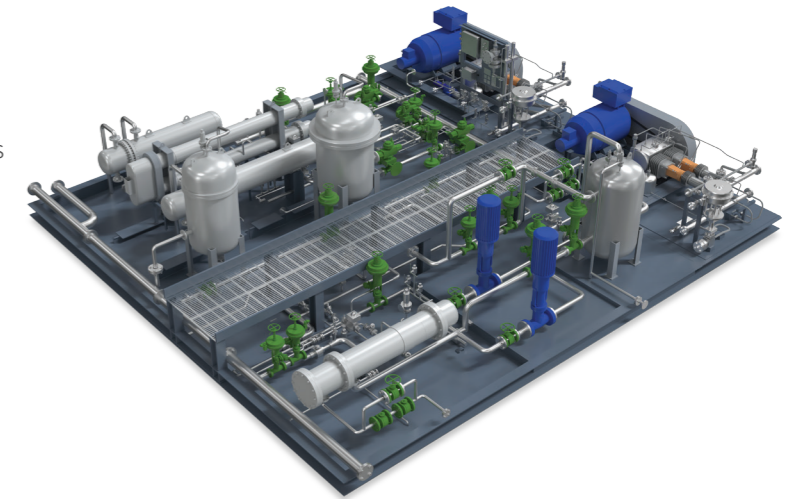

2. LP Type

— Design Data

- **LNG Feed Pump** Dis. Press 18 bar submersible centrifugal type pump X 2 sets
- **LP Vaporizer** Temp : -163°C → 45°C (Cold side)
- **Glycol Skid** Glycol Water (Water 50 : Glycol 50)
Glycol Water Pump : Vertical Inline Centrifugal type X 2 sets
Heat Exchanger : Shell&Tube or Equivalent
Glycol Water Tank : abt. 0.5 m³
- **LNG Storage Tank** IMO Type-C Single Shell Tank
IMO Type-C Double Shell Tank
IMO Type-C Lattice Tank
Material 9% Nickel Steel or Equivalent
- **LP BOG Comp.** Injected Screw Type (16 bar) X 1 set

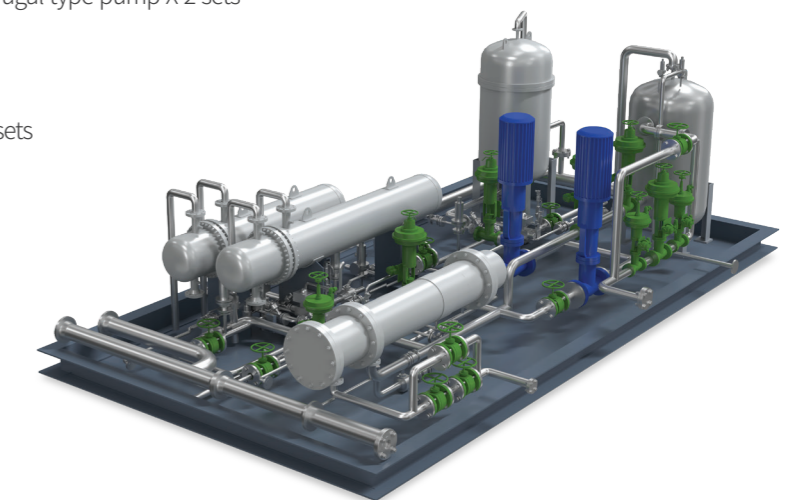

Methanol Fuel Supply System



Ammonia Fuel Supply System

Methanol Fuel Supply System은 액체상태의 Methanol을 선박의 연료로 사용하는 것으로 고도의 기술력이 필요합니다.

Ammonia Fuel Supply System은 인화점이 약 130도인 암모니아를 선박의 연료로 사용하는 것으로 액체상태로 엔진에 공급된다는 점에서 LNG, LPG, 메탄올과 공통점을 가집니다.

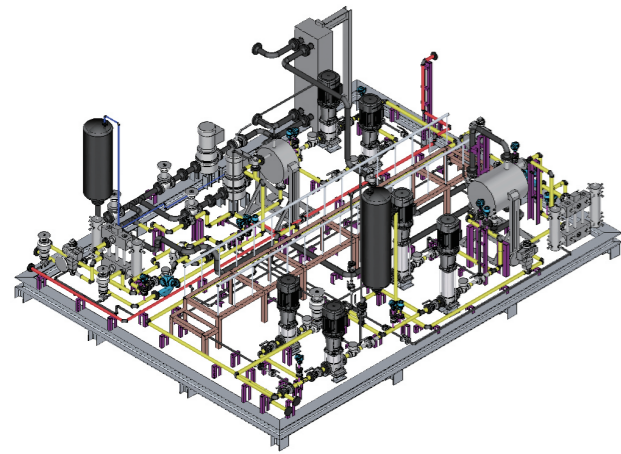

Items	Value
Pressure to engine	13 ± 0.5 bar.g
Temperature to engine	25 ~ 50 °C
Inert Gas Used	Nitrogen
Heating Media	Glycol Water (25wt.%)
Cooling/Heating Water	L.T.C.F.W(36°C)
ATEX Classification	Zone 1

Reference

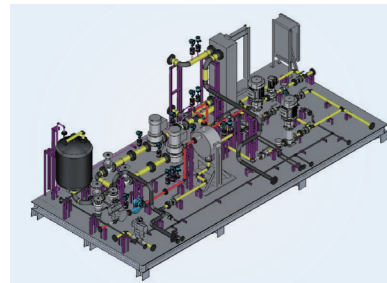

G/E+G.W LINE SKID

Propulsion Engine Fuel Supply Application

Methanol Supply Pump	Dis. Press. 6 bar.g / Sealless VFD Control
Methanol Fuel Pump	Dis. Press. 13 bar.g (Diff. Head 71 m) / Sealless VFD Control
Fuel Heater	Temp : -18 deg.C -> 25 deg.C / Glycol water 25~40%wt. Shell & Plate or Equivalent
Fuel Filter	Duplex / 10 micron
Fuel Strainer	100 micron
Fuel Pipe Material	Austenite Stainless Steel (A213-TP316)

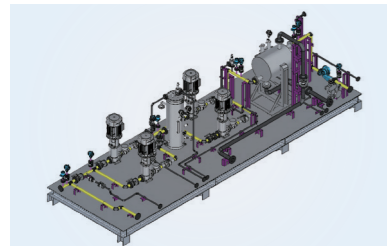

M/E LINE SKID

Generator Engine Fuel Supply Application

Methanol Supply Pump	Dis. Press. 8 bar.g / Sealless VFD Control
Fuel Heater	Temp : -18 deg.C -> 25 deg.C / Glycol water 25~40%wt. Shell & Plate or Equivalent
Fuel Filter	Duplex / 10 micron
Fuel Strainer	Y Strainer / 100 micron
Fuel Pipe Material	Austenite Stainless Steel (A213-TP316)
Main Frame Material	SS400 or eq.

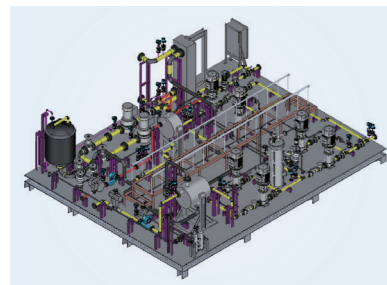

ONE SKID

Common Utility System for MeOH LFSS

Glycol water system	Vertical Inline Centifugal x 2 set Medium : Glycol water 25~40%wt. / LT water (36 deg.C) Glycol water tank : abt. 0.5 m3
N ₂ Purge & Drain System	N ₂ Supply train with valve (Automatic Purge system as an option) Pneumatic acting drain pump : 60LPM Drainage level control buffer
Safety Automation	Leak Detection Sensor (LEL 25% H/C) Control Panel & HMI

Design Data

- **LP Pump** Dis. Press. 18 bar Multi-stage centr. Pump X 1 set
- **HP Pump** Dis. Press. 88 bar Metering Pump X 1 set
- **BOG Compressor** Dis. Press. 18 bar Oil Injection Screw Water Cooled X 1 set
- **Vaporizer** Temp: -24°C → -18.7°C
- **Water seal** Temp: -24°C → 60°C
- **NH₃ Supply Skid** IMO Type-C Single Shell Tank. (abt. 5m³)
Material 9% Nickel Steel or Equivalent
LP, HP Pump
- **Heat Exchanger** Shell&Tube or Equivalent
- **NH₃ Liquefaction Skid** BOG Compressor & Separator
- **NH₃ Dilution Skid, NH₃ Catch Skid** IMO Type-C Single Shell Tank. (abt. 5m³)
- **Heat Exchanger** Shell&Tube or Equivalent
- **Aqueous NH₃ Pump** Dis. Press 7 bar Diaphragm pump X 1 set

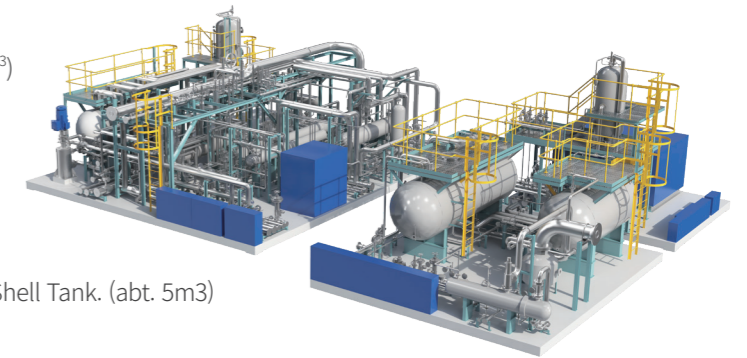

Reference

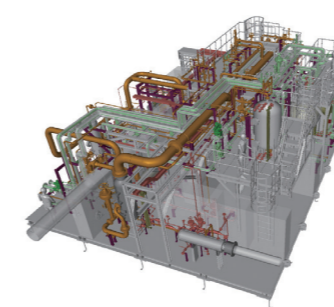

NH₃ Supply Skid

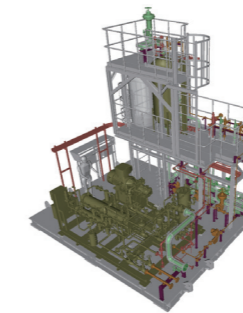

NH₃ Liquefaction Skid

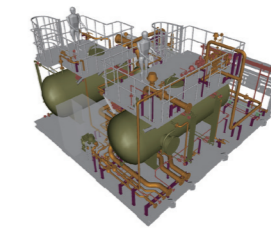

NH₃ Dilution Skid



NH₃ Catch Skid

Hydrogen Generation System

수소추출기



천연가스 및 암모니아 등 연료의 개질을 통해서 수소를 추출하고 연료전지 시스템 및 전력 저장 장치를 통하여 선박에서 쓰이는 전력을 생산합니다.

추진용 및 발전용 Engine의 대체 및 보조를 하여 강화되는 환경규제에 대응합니다.

Features



Ultra-high purity (99.999%)



Fully automatic with fail-safe control



Fully skidded, modular design for low cost installation



Low life cycle cost for catalyst



Fast initial and warm start up



Real time monitoring & control through "Smart Control Center"

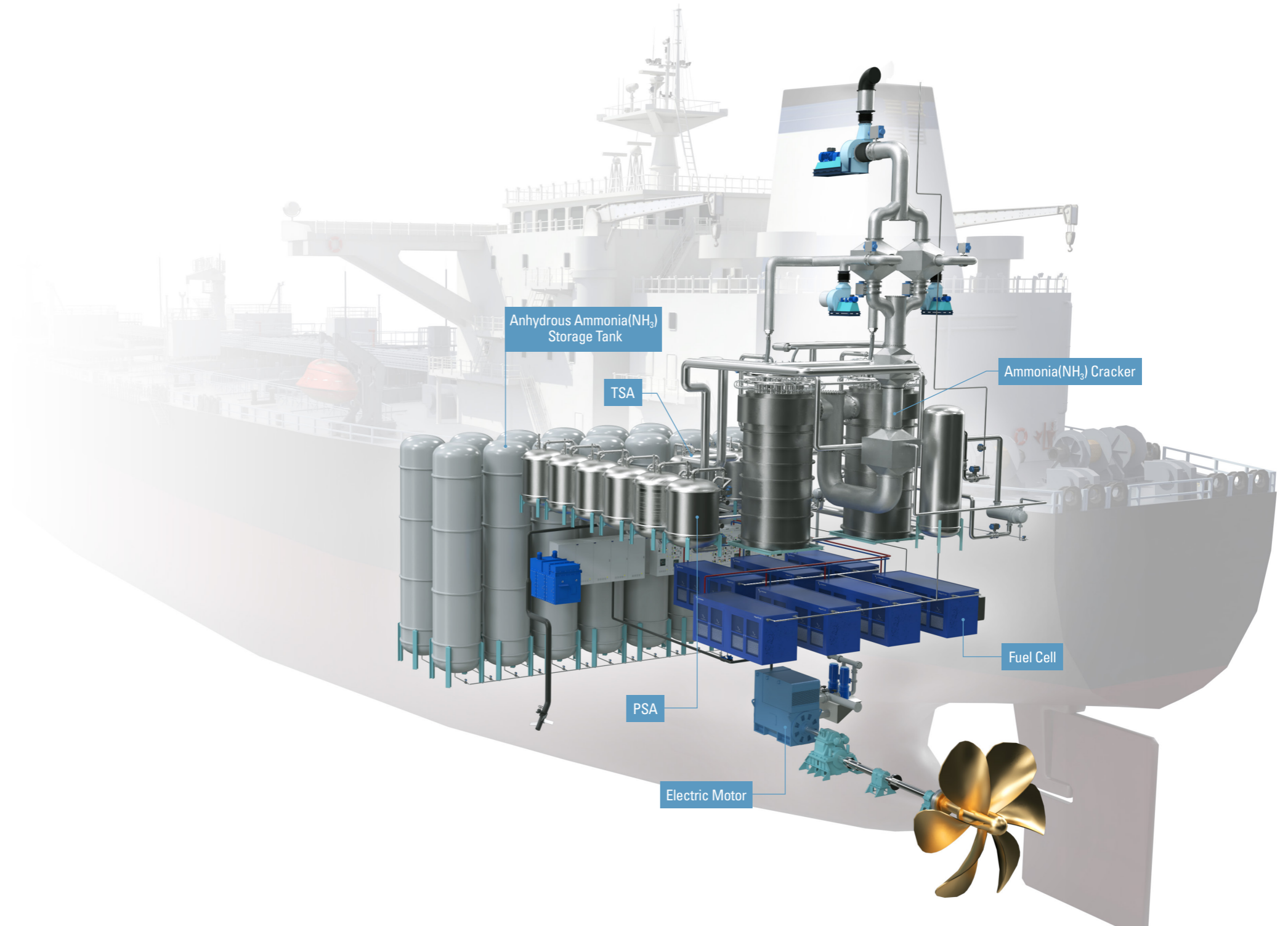

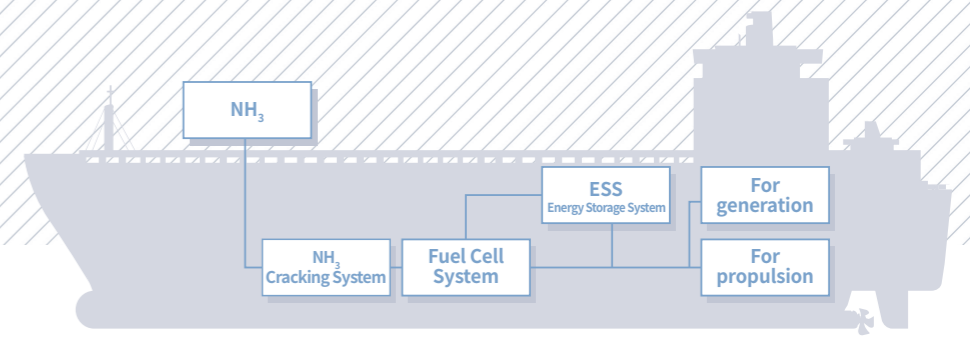

Ammonia Cracking Hydrogen Generation System

System Flow (PSA include)

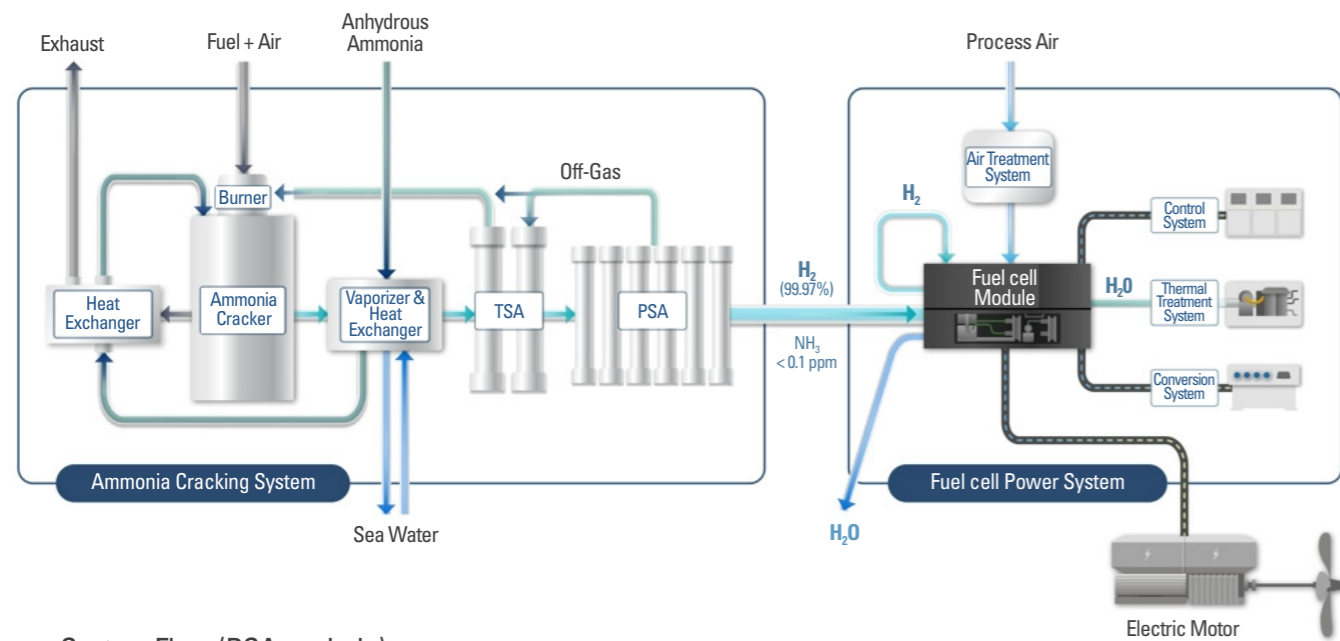

System Flow (PSA exclude)

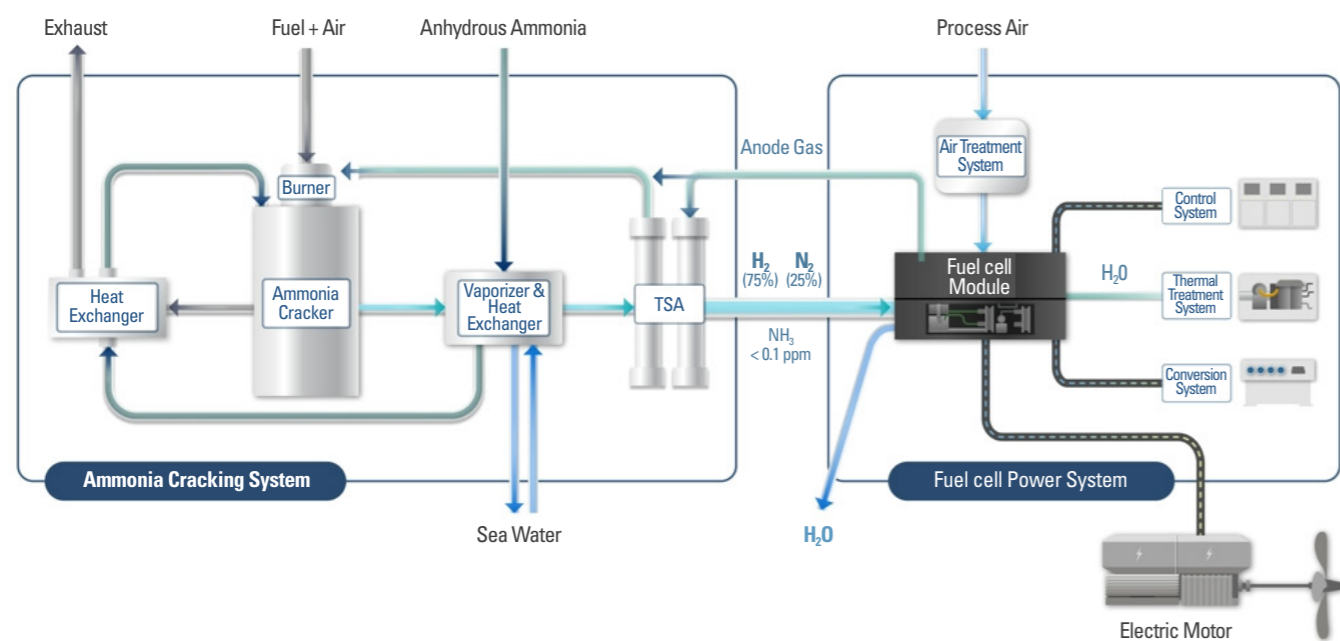

Specifications

Feed Gas	Pressure	Capacity	Product(H ₂)	
			H ₂ Purity	Pressure
Ammonia	~15 bar.g	Customized	Above 99.97-8% (NH ₃ <0.1 ppm)	10 bar.g

Installation Comparison

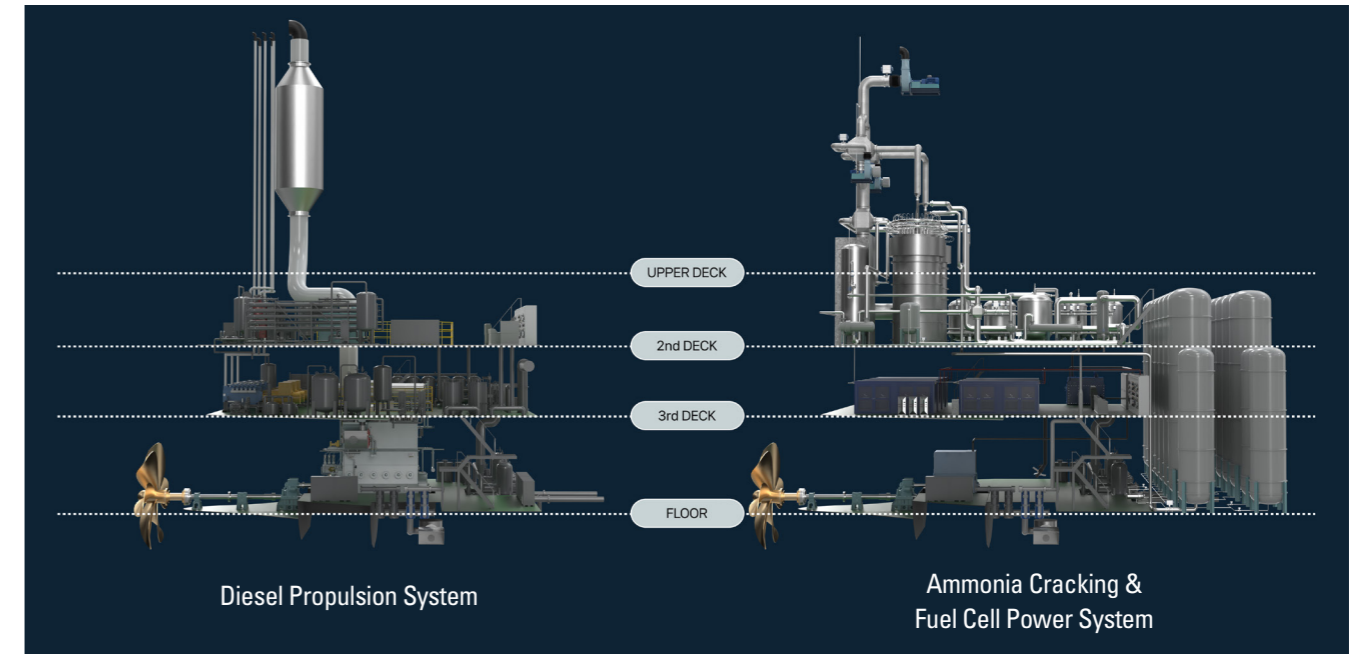

Development

[Busan Ammonia Eco-Energy Business]

50 Nm³/h NH₃ Cracking System Manufacturing / Task

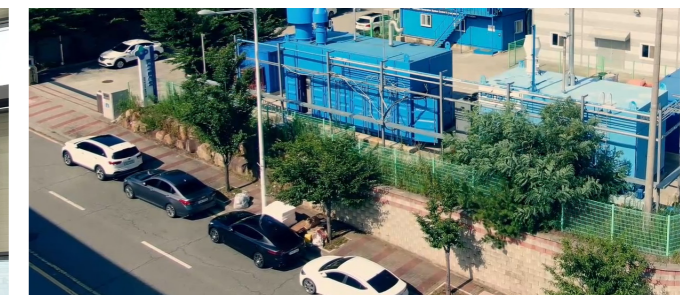

Specifications

Type	50 Nm ³ /h NH ₃ Cracking System
Cracker with TSA/PSA	High Pressure
H ₂ Capacity	50 Nm ³ /h
H ₂ Purity	Low : above 99.97-8%
Residual NH ₃ concentration	Below 0.1 ppm

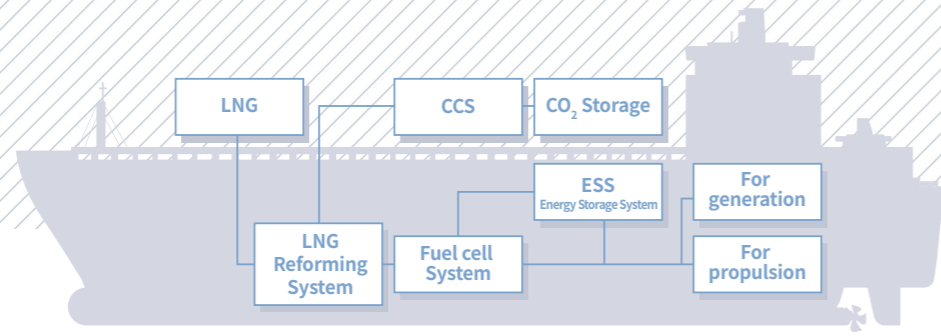

MRO Service



Maintenance



Repair



Operation

파나시아 통합관제시스템은 실시간으로 제품 데이터를 수집하고, 원격으로 장비 상태를 점검하여 고객이 시간과 장소에 구애 받지 않고 어떤 기기로도 신속하고 정확하게 문제를 해결하도록 하는 24/7 맞춤형 ICT기반 서비스입니다.

Natural Gas-Reforming Hydrogen Generation System

Steam Methan Reforming

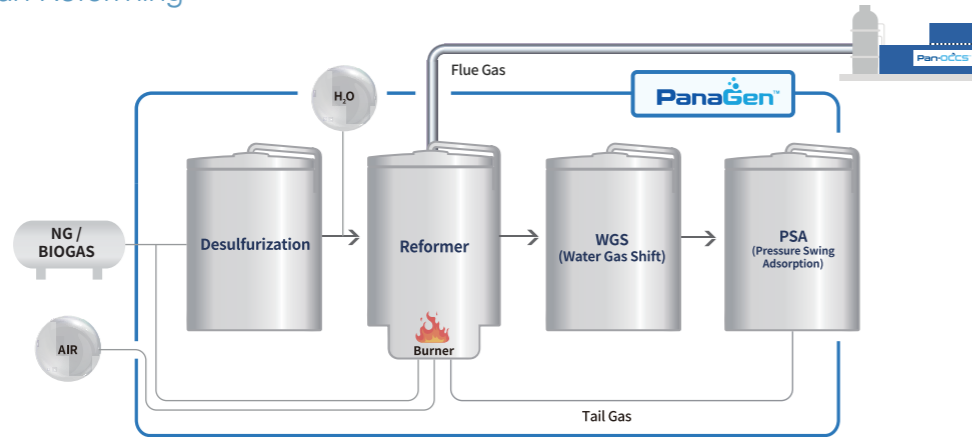

Specifications

Feed Gas	Pressure	Product(H ₂)		
		Capacity	H ₂ Purity	Pressure
Methane (Biogas and etc)	9.5 bar.g	Customized	99.999%	6 bar.g

Line-Up

Line up		PanaGen™ -30	PanaGen™ -100	PanaGen™ -250	PanaGen™ -500	PanaGen™ -2300
Output(product)						
Product(H ₂) Flow	Nm ³ /hr	~30	~100	~250	~500	~2300
	kg/day	-60	~200	~500	~1000	~4600
Purity	%vol	99.999				
Pressure	bar.g	-6.5	-6.5	-6.5	-6.5	-20
General Specifications						
Feed NG flow	Nm ³ /hr	~12	~40	~	~	~
Feed NG Pressure	bar.g	8.9 ~ 9.5				
DI Water	L/hr	~33	~100	~250	~490	~2200
Water Quality (Feed/DI)	uS/cm	Feed Water : <650, Deionized Water : <1				
Comp. Air Quality		ISO 8573-1 Class 3/3/4				
Operating Amb. Temp.	°C	-20 ~ 40				
Electricals						
Power Source		380VAC 3phase 60Hz				
Electricity	kWh	~14	~30	~60	~150	~300



파나시아는 고객 편의를 위한 차별화된 서비스를 제공합니다.

실시간으로 제품 데이터를 수집하고, 원격으로 장비 상태를 점검하여 고객이 시간과 장소에 구애 받지 않고 어떤 기기로도 신속하고 정확하게 문제를 해결하도록 하는 24/7 맞춤형 ICT 기반 서비스입니다. 또한 축적된 데이터를 통하여 문제점을 사전에 진단하고 최적의 성능을 유지할 수 있도록 서비스를 제공하고 있습니다.

BALLAST WATER TREATMENT SYSTEM
GLOEn-Patrol™

DE-ION SYSTEM
PaSOx™

DE-NOX SCR SYSTEM
PaNOx™

Pan-OCSS™

PanaGen™

PanFGSS™

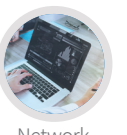

Network

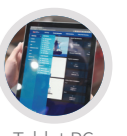

Tablet PC



Mobile



안전관리

- 수소 누출 등 안전관리
- 실시간 확인 및 경보 통보
- 문제 발생 사전 예측 및 예방



제품진단

- 생산량, 발전량, 효율 등 실시간 모니터링
- 고장 진단 및 분석



효율적 관리

- 온라인 원격 업데이트 지원
- Big Data 기반 유지관리
- 소모품 교체 알림
- 운영 손실 최소화

MRO Service E-Learning Program

파나시아는 시간과 장소에 구애 받지 않는 제품 운용에 관련한 프로그램을 제공합니다.

파나시아의 교육 프로그램 서비스 E-Learning Program은 고객의 상황에 따라 On-Off line에서 자유롭게 사용하도록 CBT & IBT 방식으로 구성되어 있어 언제 어디서든 교육 및 문제 발생 시 대처가 가능합니다.



Learning Program Contents

Chapter	Contents
1	Understanding system of product
2	Standard operating procedures
3	Compliance issues
4	Installation requirement
5	Maintenance requirement
6	Troubleshooting for the system/unit
7	Troubleshooting for the component/device

CBT (Computer Based Training Program)



IBT (Internet Based Training Program)

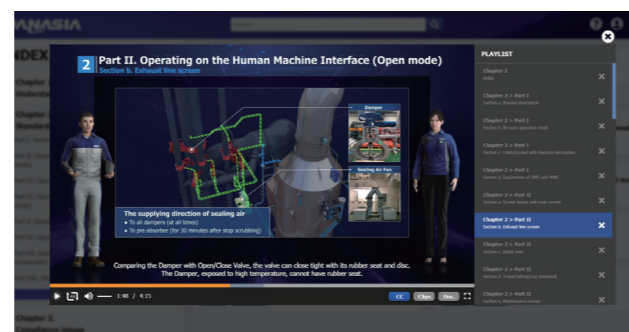

Claim Handling System



당사의 서비스 및 유지보수는 인적 오류를 최소화 하기 위해 모든 업무가 디지털로 진행됩니다.

제품이 고객으로 인도된 후, 고객에게 당사의 유지보수 시스템인 Claim Handling System의 ID와 비밀번호가 부여되며 접속 권한이 주어지게 됩니다.

해당제품에 문제 발생 시, 고객이 문제 내용을 CHS에 등록하면 당사 담당자가 배정되고, 각 담당자는 해당 Claim의 관리 및 지속적인 모니터링을 통해 문제해결을 실시합니다. 또한 RPA 시스템 도입을 통해 더욱 신속하고 편리한 운영 및 관리로 고객들에게 질 높은 서비스를 제공합니다.

Maintenance work process

유지보수 종료 후 서비스 리포트는 자동으로 고객사로 전달되어 실시간 처리내용 확인이 가능하며, 당사에서 서비스 사항에 대한 재발 방지를 위해 내부적인 피드백을 통해 제품 개선에 활용합니다.

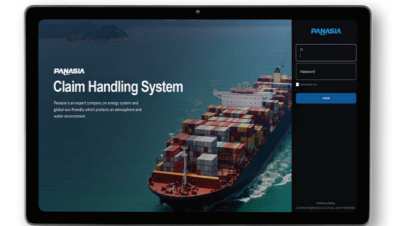

PANASIA

HEAD OFFICE&FACTORY 55, Mieumsandan3-ro, Gangseo-gu, Busan, 46744, Korea
TEL: +82-51-831-1010 FAX: +82-51-831-1399
www.worldpanasia.com E-mail: panasia@worldpanasia.com

MARKETING TEL: +82-70-4860-7912 E-mail: marketing@worldpanasia.com

EUROPE B.V. TEL: +31-10-79-53-005 E-mail: europe@worldpanasia.com

JAPAN CORPORATION TEL: +81-6-4795-8748 E-mail: japan@worldpanasia.com

CHINA CORPORATION TEL: +86-21-6235-1601~3 E-mail: china@worldpanasia.com



친환경적이고 지속가능한 가치를 추구하는 (주)파나시아의 기업 이념을 담아,
본 책자는 자연분해 및 종이 재생이 용이한 콩기름 잉크로 인쇄되었습니다.

2024/01/09 ver.