



PANASIA

PANASIA: A global leader that
challenges new creation using
eco-friendly technologies

Global Leader in Smart & Green Technology

Global eco-friendly and energy system expert that increases the value of living and opens doors to a sustainable future

- 04 About PANASIA
- 08 Energy Solutions
- 16 Air Solutions
- 19 Water Solutions
- 22 Services
- 27 Global Network

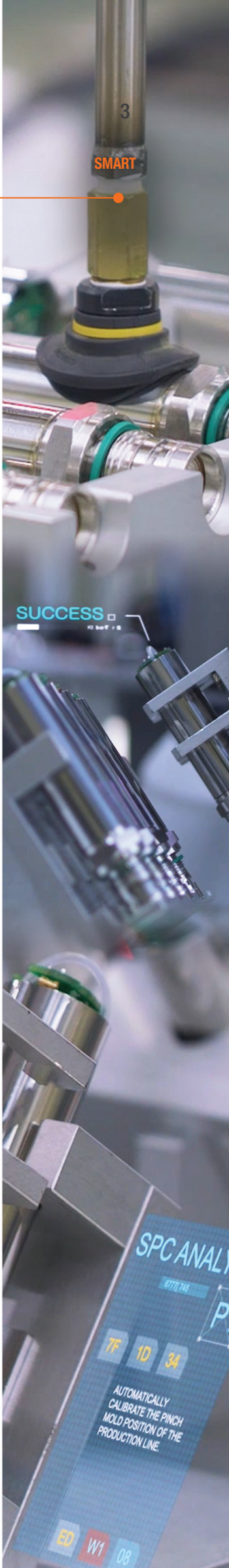

Panasia Group_

We are heading to the future with eco-friendly solutions

PANASIA is a green energy solution provider that leads the way in building a future in which humans and nature coexist.

At PANASIA, we are continuously working to take risks and develop technologies powered by nature based on the standards of nature across various areas, from the air solutions to the water solutions, and to our energy solutions.

We offer high-quality ICT-based products by adopting our unique "SMART PANASIA" system, which encompasses all processes from product planning to design, production, and to services, and allows our technologies to learn and evolve on their own.

With its core technologies and years of experience, PANASIA has become a global leader that uses its technology to respond to demands in various environmental areas.



WATER SOLUTIONS

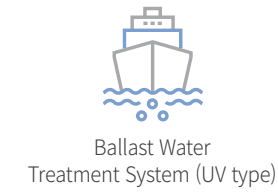

Ballast Water Treatment System (UV type)

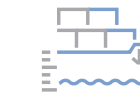

Measurement Control System



WTS for Exhaust Gas System (Chemical / Membrane)

AIR SOLUTIONS



De-SOx System (Scrubber)



De-NOx System (SCR)



Engine Exhaust Recycling System (iCER)

ENERGY SOLUTIONS



Hydrogen Generation System



Carbon Capture and storage System (CCS/OCCS)



Fuel Supply System (LNG/Ammonia/Methanol)

EM SOLUTIONS



Alternative Maritime Power System (AMP)



Amine Based Solvent



CO₂ Liquefaction System



N₂ Generator



Creation with the spirit of challenge

At PANASIA, we are creating a future where humans and nature coexist.

Since its inception in 1989, with the goal of "becoming a technology pioneer," PANASIA has become a global leader in the fields of air quality, water quality, and hydrogen business by developing proprietary technologies and expanding its product lines.

Our infinite passion for eco-friendly technologies has connected PANASIA locally to Asia, and then to the whole world. Currently, we are operating local subsidiaries in Europe, China, and Japan, all the while working closely with retailers all over the world to strengthen our global competitiveness.

Founded under the motto, "Seeking creative challenges," we at PANASIA have worked continuously to take risks and create a sustainable future, not just a better tomorrow.

ESG Management

Since its inception, PANASIA has continued its sustainability efforts to grow together through ESG management integrating environmental, social, and governance practices, instead of just pursuing profits.

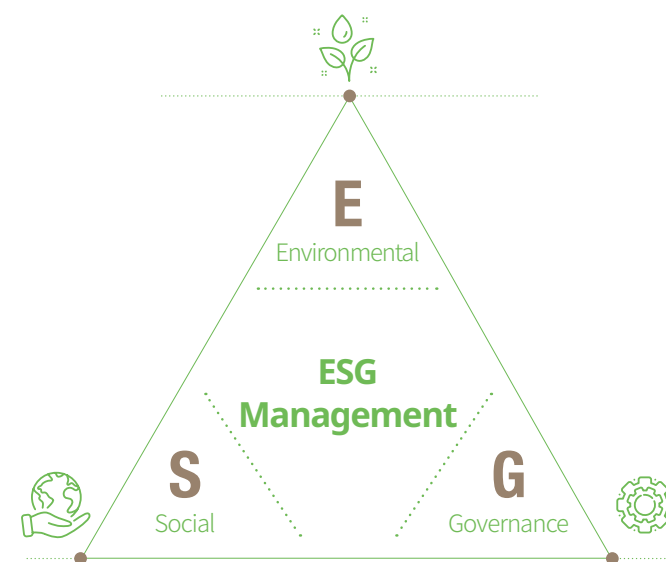

- E Environmental**
 - Developing technologies in the fields of Water solutions, Air solutions, and Energy solutions
 - Eco-friendly R&D in keeping with global trends and government policies
 - Operating an environmental management system since obtaining ISO14001 certification in May 2009
 - Building eco-friendly facilities to reduce use of coal energy
- S Social**
 - Living with communities by providing support to the neglected and the underprivileged
 - Helping talent become self-sufficient by creating jobs and fostering human resources
 - Eco-friendly social services to preserve the environment and mitigate climate change
 - Employee-engagement volunteering activities
- G Governance**
 - Legal compliance and ethics on the basis of our social responsibilities, which involves ethical management, win-win management, and environmental management
 - Transparent business operations by operating internal/external reporting mechanisms

Smart PANASIA

Advanced technology for building best-in-class equipment

Smart PANASIA produces 'customized products' at the minimum cost and time by utilizing ICT to integrate all processes, from product planning and design to production and service. Also, even after delivery, it supports the integrated control system, which is used for maintenance and repairs, and services such as our E-Learning Program to increase convenience for our customers.

Process

Design – Delivery Process

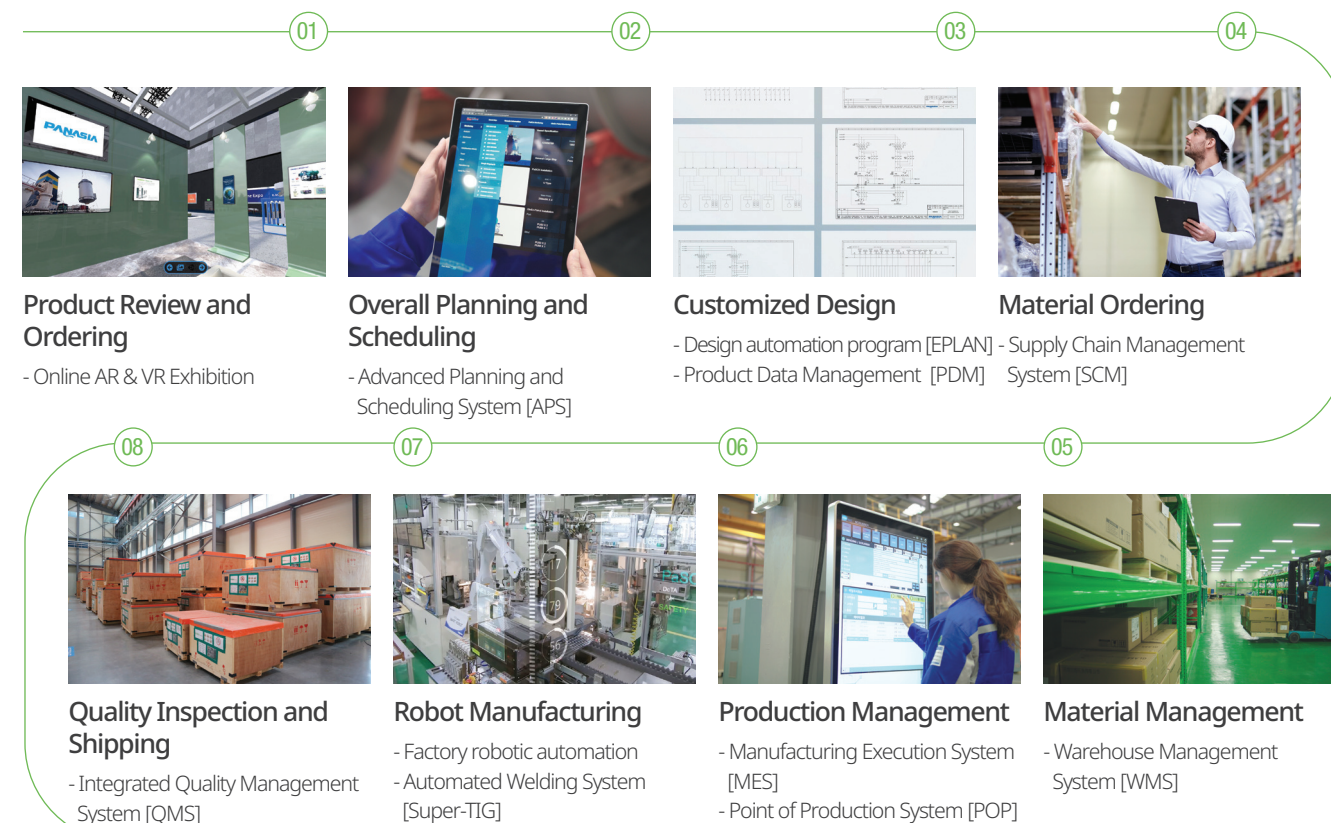

Training – After-sales service (A/S)





Carbon Capture and Storage System (CCS)

Pan-CCS™

Pan-CCS™ (Carbon Capture and Storage System) is a system that isolates from the atmosphere carbon dioxide emissions from large-sized fossil fuel-powered emitters, such as power plants, steel and cement plants, and ships.



Application

Pan-OCCS™



for Ship

- Capacity 1 / 2 / 3 CO₂ ton/h ~
- Purity 99.9% CO₂
- feature Changing concentration of CO₂
- Space limitation
- CCS for marine condition
- Load change of engine

Pan-CCS™



for Industrial Plant

- Capacity 5 / 10 / 15 CO₂ ton/h ~
- Purity 99.9% CO₂
- feature Large scale of CCS
- Long-term Stability
- Cost efficient



for Hydrogen Generation System

- Capacity 80 / 200 / 400 CO₂ kg/h
- Purity 99.9% CO₂
- feature High concentration of CO₂
- Modular design
- High purity of CO₂

Main Components

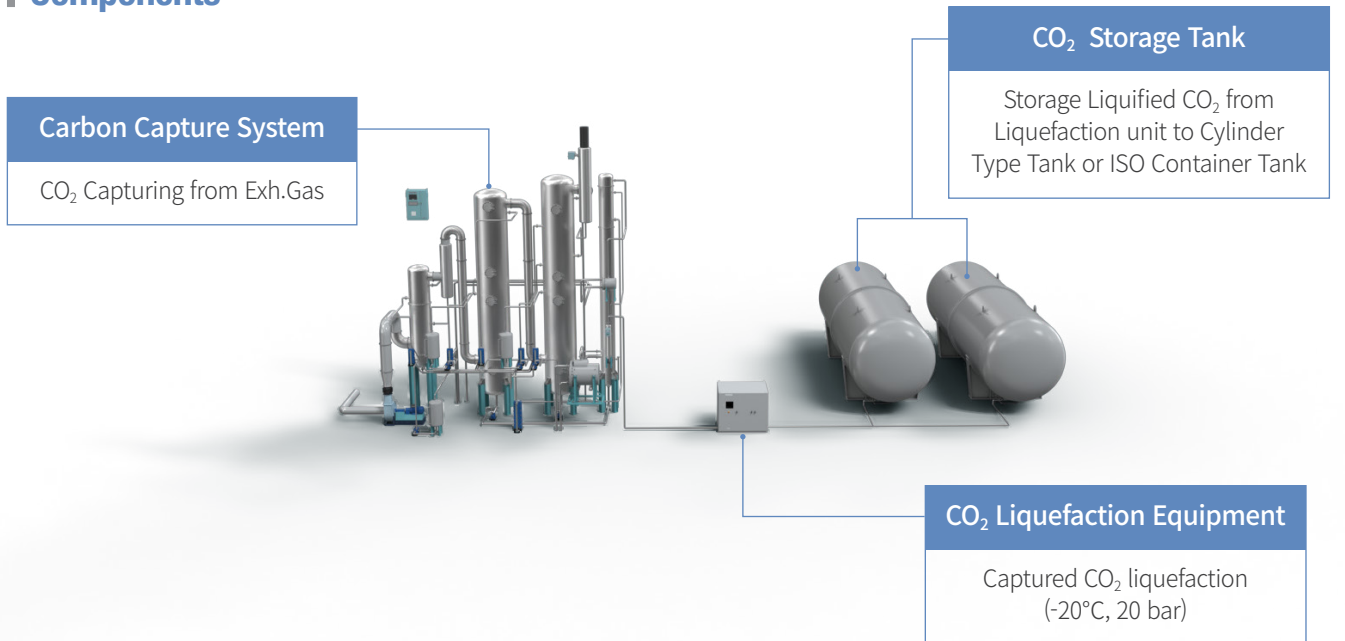

Carbon Capture Diagram

1 Pre-treatment of flue gas

Flue gas is cooled in the quenching tower. When the particles and sulfur oxide are removed, the gas is pressurized by the intake fan and transferred to the absorber tower.

2 CO₂ absorption

Once cooled, the gas comes into contact with the chemical solvent in the absorber, and CO₂ is selectively absorbed. To ensure efficient delivery of the substance and keep the tower size to a minimum, high-performance packing and an appropriate layout of the internal components are required.

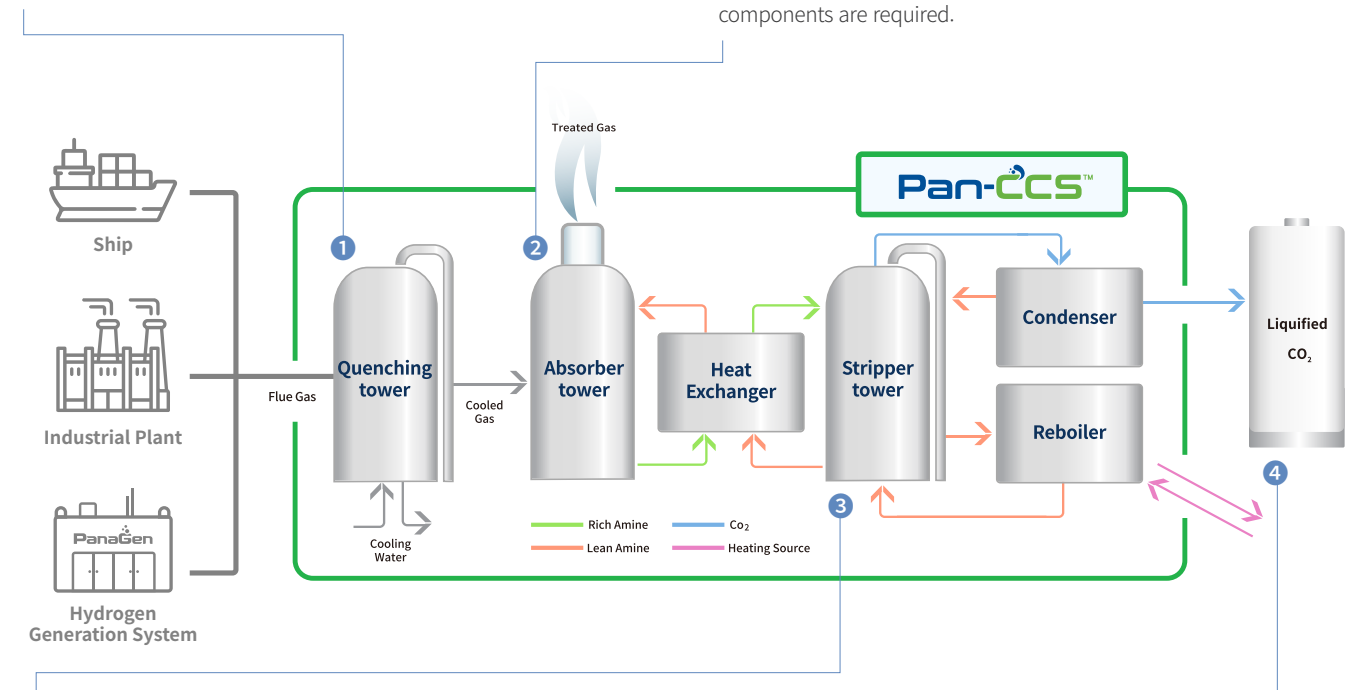

3 Regeneration

A solvent that has absorbed CO₂ is transferred to the stripper tower. The high-temperature vapor in the reboiler causes CO₂ to be removed from the solvent. In the cooling tower, it breaks down into water and CO₂. Then, the water is recovered and sent to the stripper while CO₂ is transferred to the liquefaction process.

4 Liquefaction & storage

Adding pressure and cooling for liquefaction purposes to meet the needs of storage containers and buyers.



Fuel Supply System

PanFGSS™

The fuel gas supply system of PANASIA is a device that vaporizes alternative energy such as LNG, ammonia, and methanol and supplies it to the ship engine.



- Natural Gas Fuel Supply System
- Methanol Fuel Supply System
- Ammonia Fuel Supply System

1. Natural Gas Fuel Supply System

1. HP/LP Type

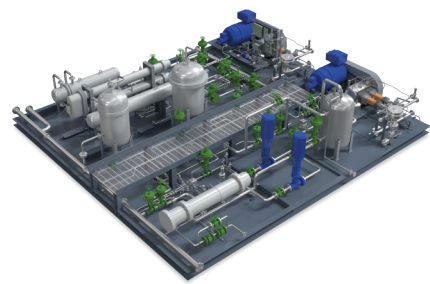

- **HP Pump** Dis. Press. 300 bar reciprocating pump X 2 sets
- **LNG Feed Pump** Dis. Press 12 bar submersible centrifugal type pump X 2 sets
- **LP Vaporizer** Temp : -163°C → 45°C (Cold side)
- **HP Vaporizer** Temp : -163°C → 45°C (Cold side)
- **Glycol Skid** Glycol Water (Water 50 : Glycol 50)
Glycol Water Pump : Vertical Inline Centrifugal type X 2 sets
Heat Exchanger : Shell&Tube or Equivalent
Glycol Water Tank : abt. 0.5 m³
- **LNG Storage Tank** IMO Type-C Single Shell Tank
IMO Type-C Double Shell Tank
IMO Type-C Lattice Tank
Material 9% Nickel Steel or Equivalent

2. LP Type



- **LNG Feed Pump** Dis. Press 18 bar submersible centrifugal type pump X 2 sets
- **LP Vaporizer** Temp : -163°C → 45°C (Cold side)
- **Glycol Skid** Glycol Water (Water 50 : Glycol 50)
Glycol Water Pump : Vertical Inline Centrifugal type X 2 sets
Heat Exchanger : Shell&Tube or Equivalent
Glycol Water Tank : abt. 0.5 m³
- **LNG Storage Tank** IMO Type-C Single Shell Tank
IMO Type-C Double Shell Tank
IMO Type-C Lattice Tank
Material 9% Nickel Steel or Equivalent
- **LP BOG Comp.** Injected Screw Type (16 bar) X 1 set

Methanol Fuel Supply System

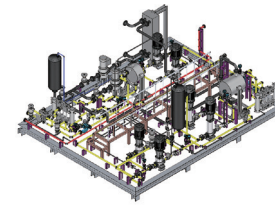

Items	Pressure to engine	Temperature to engine	Inert Gas Used	Heating Media	Cooling/Heating Water	ATEX Classification
Value	13 ± 0.5 bar.g	25 ~ 50 °C	Nitrogen	Glycol Water (25wt.%)	L.T.C.F.W(36°C)	Zone 1

Reference

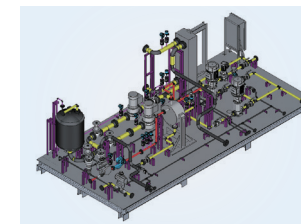

G/E+G.W LINE SKID

Propulsion Engine Fuel Supply Application

Methanol Supply Pump	Dis. Press. 6 bar.g / Sealless VFD Control
Methanol Fuel Pump	Dis. Press. 13 bar.g (Diff. Head 71 m) / Sealless VFD Control
Fuel Heater	Temp : -18 deg.C -> 25 deg.C / Glycol water 25~40%wt. Shell & Plate or Equivalent
Fuel Filter	Duplex / 10 micron
Fuel Strainer	100 micron
Fuel Pipe Material	Austenite Stainless Steel (A213-TP316)

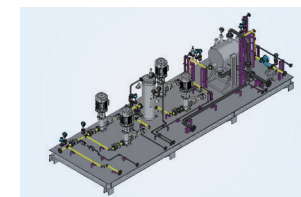

M/E LINE SKID

Generator Engine Fuel Supply Application

Methanol Supply Pump	Dis. Press. 8 bar.g / Sealless VFD Control
Fuel Heater	Temp : -18 deg.C -> 25 deg.C / Glycol water 25~40%wt. Shell & Plate or Equivalent
Fuel Filter	Duplex / 10 micron
Fuel Strainer	Y Strainer / 100 micron
Fuel Pipe Material	Austenite Stainless Steel (A213-TP316)
Main Frame Material	SS400 or eq.

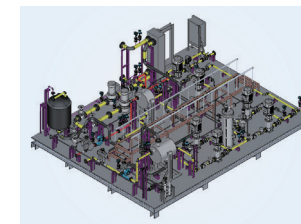

ONE SKID

Common Utility System for MeOH LFSS

Glycol water system	Vertical Inline Centrifugal x 2 set Medium : Glycol water 25~40%wt. / LT water (36 deg.C) Glycol water tank : abt. 0.5 m ³
N ₂ Purge & Drain System	N ₂ Supply train with valve (Automatic Purge system as an option) Pneumatic acting drain pump : 60LPM / Drainage level control buffer
Safety	Leak Detection Sensor (LEL 25% H/C)
Automation	Control Panel & HMI

Ammonia Fuel Supply System

Design Data

- **LP Pump** Dis. Press. 18 bar Multi-stage centr. Pump X 1 set
- **HP Pump** Dis. Press. 88 bar Metering Pump X 1 set
- **BOG Compressor** Dis. Press. 18 bar Oil Injection Screw Water Cooled X 1 set
- **Vaporizer** Temp: -24°C → -18.7°C
- **Water seal** Temp: -24°C → 60°C
- **NH₃ Supply Skid** IMO Type-C Single Shell Tank. (abt. 5m³)
Material 9% Nickel Steel or Equivalent
LP, HP Pump
- **Heat Exchanger** Shell&Tube or Equivalent
- **NH₃ Liquefaction Skid** BOG Compressor & Separator
- **NH₃ Dilution Skid, NH₃ Catch Skid** IMO Type-C Single Shell Tank. (abt. 5m³)
- **Heat Exchanger** Shell&Tube or Equivalent
- **Aqueous NH₃ Pump** Dis. Press 7 bar Diaphragm pump X 1 set

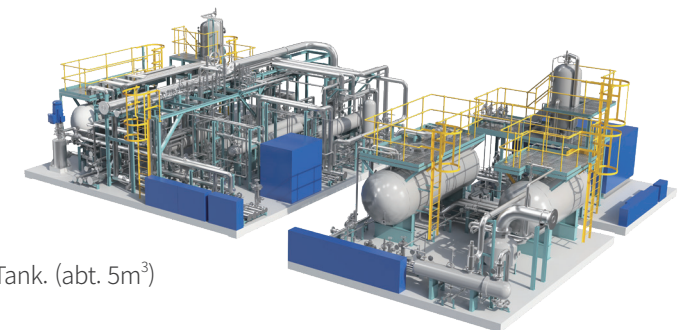



Hydrogen Generation System



PanaGen™ generates hydrogen through cracking ammonia and reforming LNG or biogas on-site to utilize for household, construction, and industrial plants, and it can also be used for hydrogen-fueled vessels.

The hydrogen generation system for use in buildings to generate power and the small&mid sized hydrogen generation system that can store and utilize the hydrogen generated on site can be used on ships that use hydrogen as a propulsion fuel.



I Application

for Houses (Small-capacity)



Capacity 1~300 Nm³/hr
Purity 75% ~ 99.999% H₂
Type SMR / Membrane
Purification method PrOx / Membrane / PSA

for Ship



Capacity 100/150/300 Nm³/hr
Purity 99.999% H₂
Type SMR / Membrane
Purification method PSA / Membrane

for Industrial Plant



Capacity 500/1,000/10,000 Nm³/hr
Purity 99.999% H₂
Type SMR / Membrane
Purification method PSA / Membrane

I Ammonia Cracking Hydrogen Generation System

System Flow (PSA include)

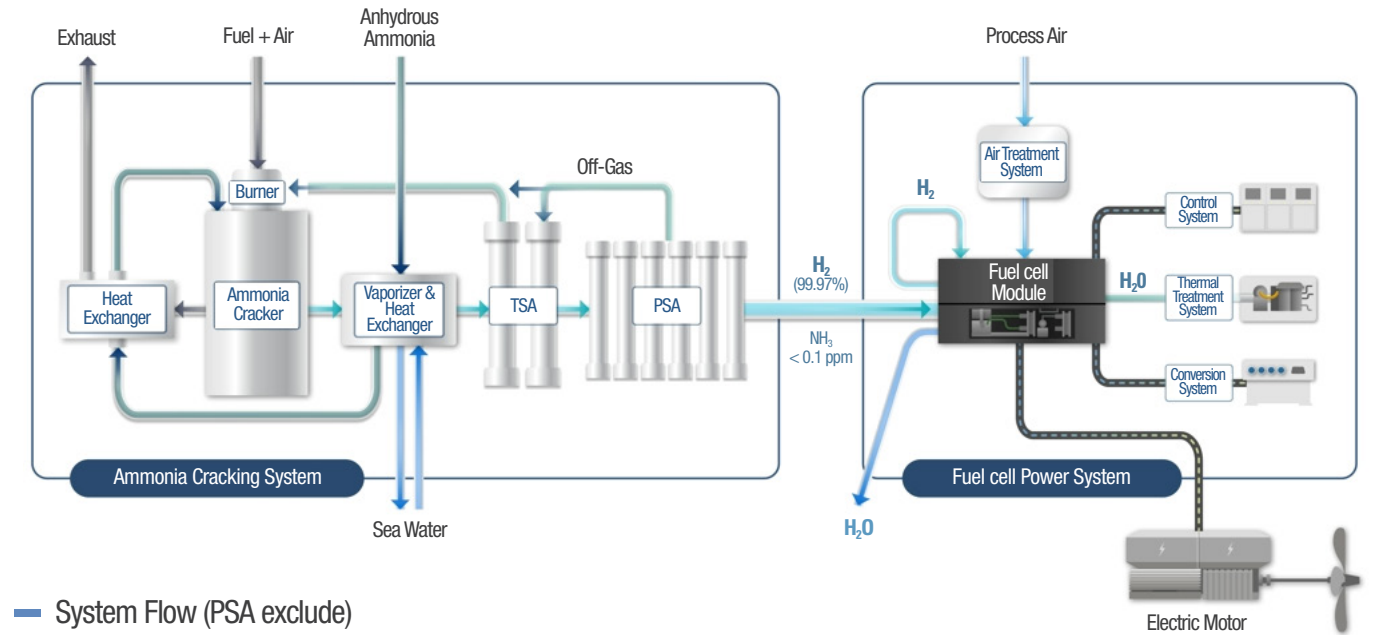

System Flow (PSA exclude)

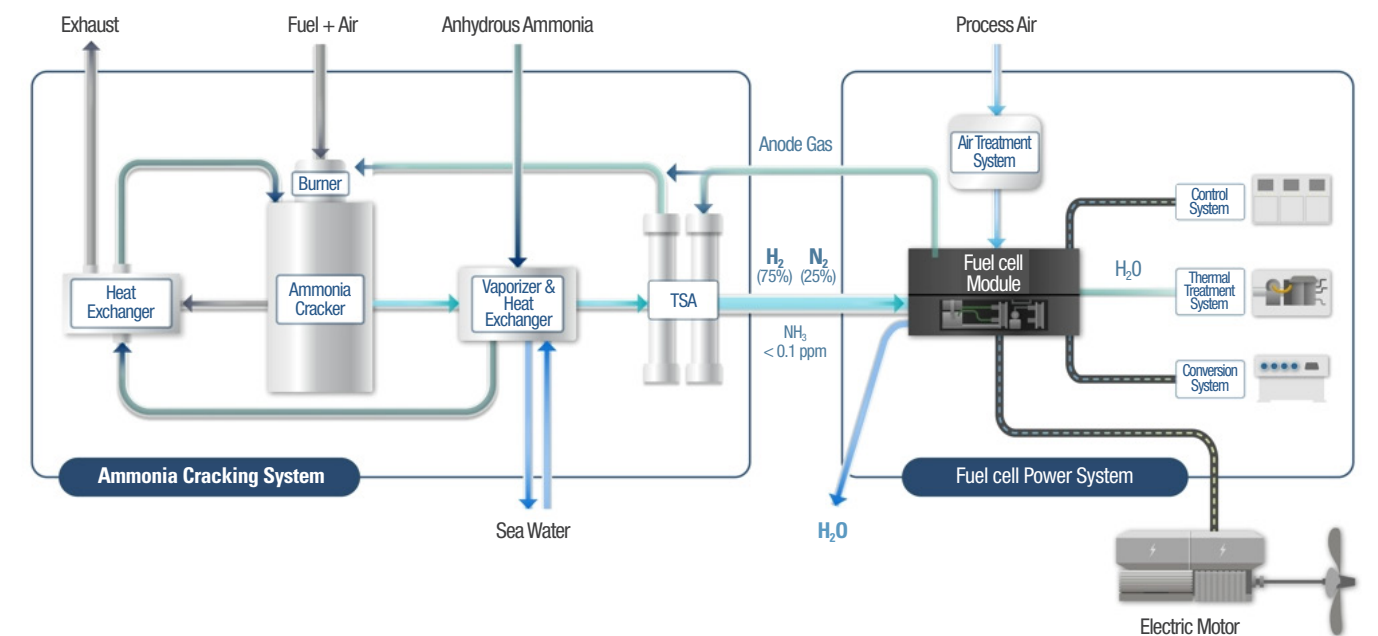

I Natural Gas-Reforming Hydrogen Generation System

Steam Methan Reforming

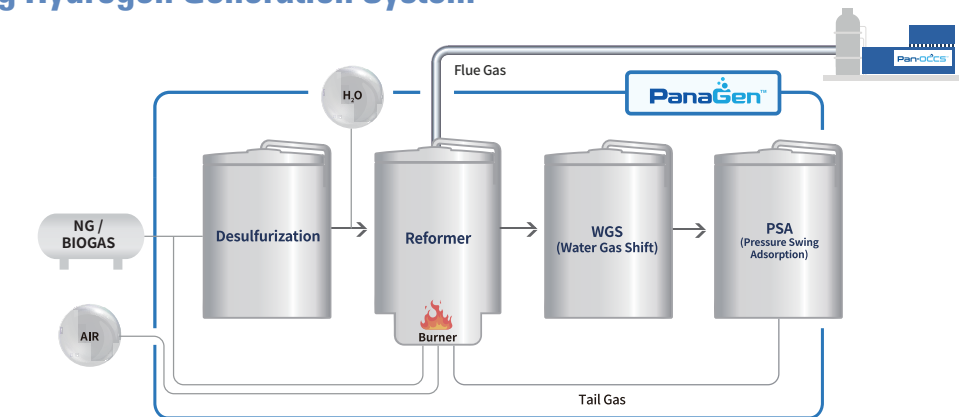

Specifications

Feed Gas	Pressure	Product(H ₂)		
		Capacity	H ₂ Purity	Pressure
Methane (Biogas and etc)	9.5 bar.g	Customized	99.999%	6 bar.g



Alternative Maritime Power System (AMP)

AMP (Alternative Maritime Power) is a facility that allows ships to receive electricity from shore while they are docked in port without using auxiliary engines.

AMP allows for stopping the operation of ship engines during docking, resulting in fuel cost savings and mitigation of environmental pollution caused by exhaust emissions.

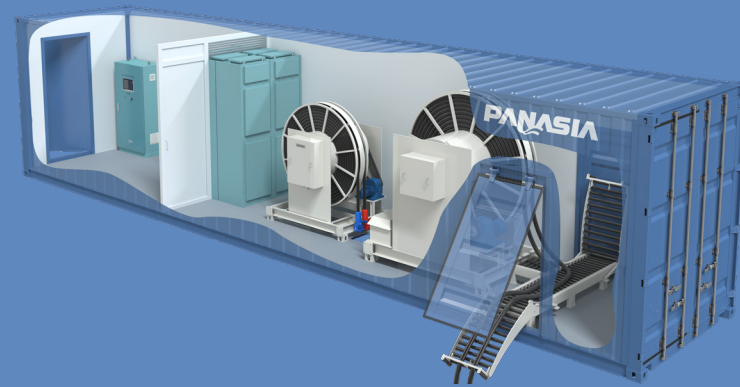

AMP Cable Reel (Cable Management System)

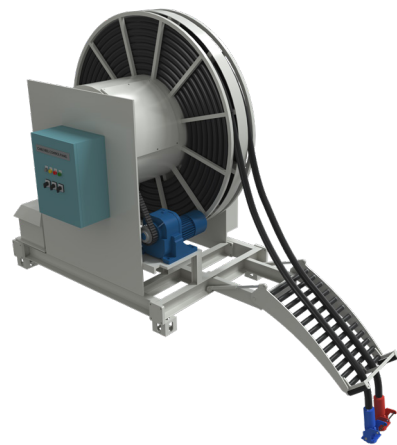

Features

- Encoder + inverter control enables cable automatic tension control
- AMP Cable tensile strength is 11,100N
- Use TPU (Thermoplastic Polyurethane) for AMP cable outer sheath material
- AMP cable is non-hygroscopic and resistant to oil, SEA AIR & SEA WATER, UV and Ozone.

Shore Conn. Panel



AMP Incoming Panel



Socket Box



Transformer



AMP System Application

1. Cable Reel Type

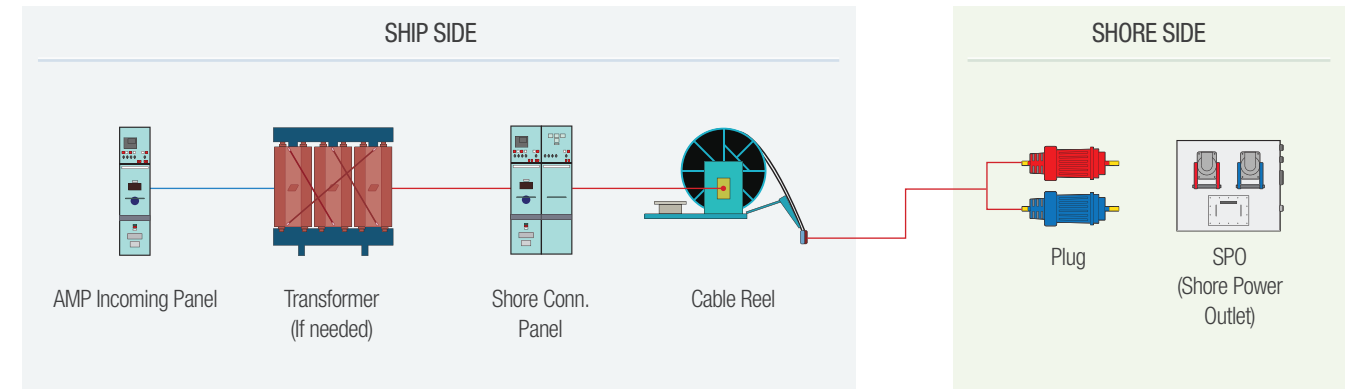

2. Socket Box Type

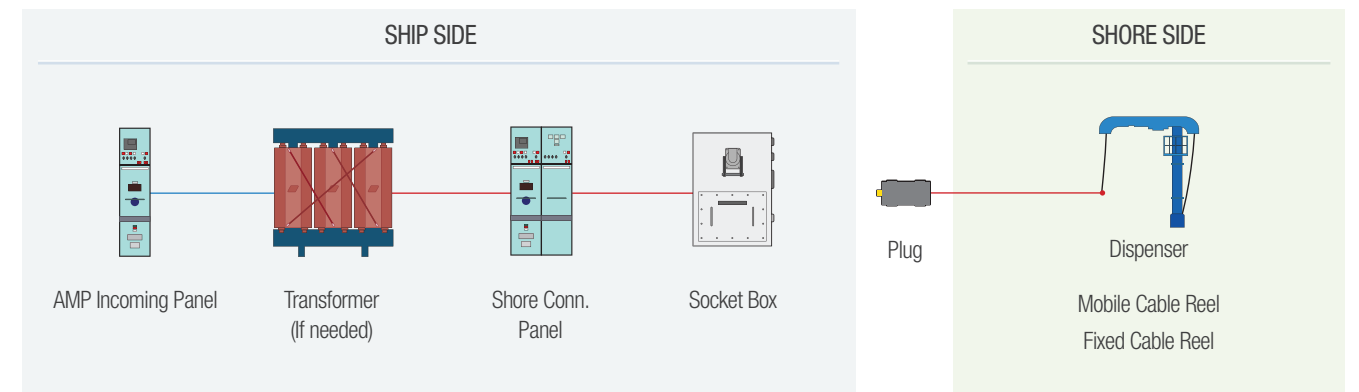

3. Fixed Container Type

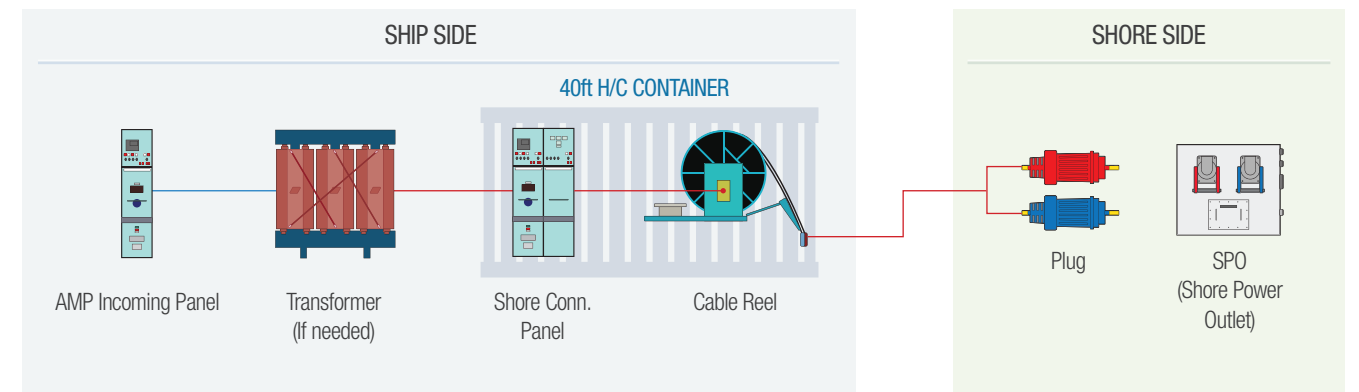

4. Movable Container Type

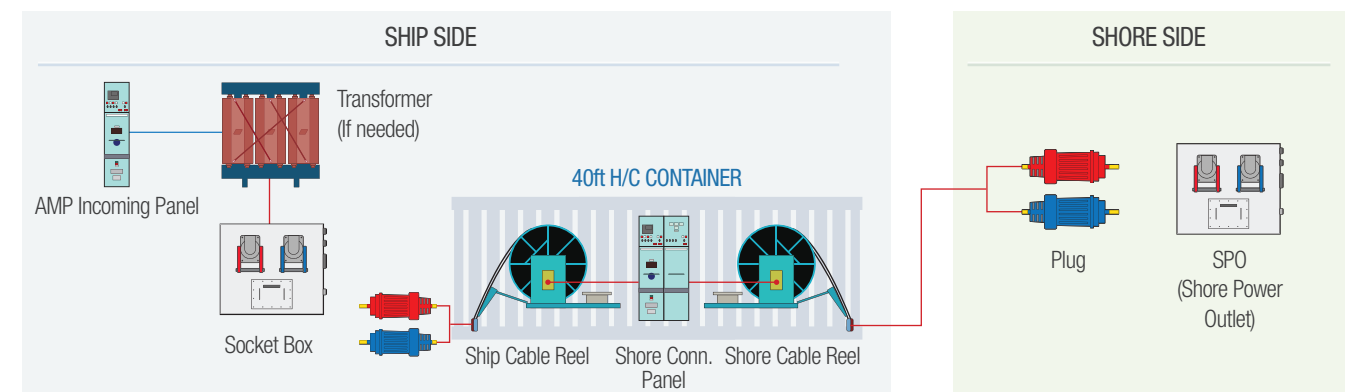



De-SOx Scrubber System

PANASIA's De-SOx scrubber system PaSOx™ is an air quality environment solution that reduces sulfur dioxide emissions in exhaust gas caused by burning of engine fuels.

PaSOx™ smart

The onshore scrubber is used in power plants or industrial facilities that require reduction of SOx emissions.

The wet scrubber, which uses seawater for ship applications, helps prevent air pollution by reducing sulfur oxide emissions caused by burning of high-sulfur fuel oil.



Product Line-up

PANASIA's PaSOx™ provides a customized solution made for various applications, regardless of the plant size, the type or size/shape of the ship.

PaSOx™ smart U-Type

1-80MW



PaSOx™ smart I-Type

1-80MW



PaSOx™ smart v.sq

1-70MW



PaSOx™ smart v.mcr

1-6MW



Main Components

Water Treatment Unit

WATERCOMMANDER™

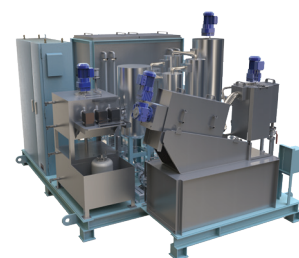

Water Monitoring System



Gas Monitoring System



De-NOx SCR System

PaNOx™ smart

PANASIA's De-NOx SCR system PaNOx™ is an eco-friendly solution that uses the Selective Catalytic Reduction mechanism (SCR system) to decompose nitrogen oxides from exhaust gas into harmless water (H₂O) and nitrogen (N₂) and releases them. We offer PaNOx™ for large-scale onshore systems for releasing exhaust gas emissions, such as power plants and boilers, and PaNOx™ Marine for onboard applications, which is designed to meet the IMO Tier III standards.



Application

PaNOx™ smart

PaNOx™ has been continuously installed in fuel-burning facilities with NOx emissions, including onshore power plants such as HRSG and boilers. The system has been actively used not only locally but all over the world to meet the regulatory requirements, from California, where the world's strictest NOx regulations apply, to Iran and Saudi Arabia.



HRSG



Boiler

PaNOx™ Marine smart

On January 1, 2016, the International Maritime Organization (IMO) brought into effect Tier III, a convention aimed at reducing NOx emissions from diesel engines by more than 80%. To achieve this certification, products must meet the regulatory requirements of Tier III, such as installing systems like SCR on marine engines that meet the Tier III requirements.



Shipbuilding

Main Components

V1 / Reactor + Mixer + Pump Unit + Dosing Control Unit + Control Panel

V2 / Reactor + Mixer + Control Panel + IDU

V3 / Reactor + Mixer + PanSIS (KR+ABS Type Approval)

PaNOx smart V2 (Under 6 sets of Engine)

The existing Pump Unit & Dosing Control Unit can be manufactured with one equipment called the IDU (Integrated Dosing Unit) for more efficient installation.

PaNOx smart V3 (Under 4 sets of Engine)

The IDU equipment in V2 is combined with the Control Panel and manufactured with a single equipment called PanSIS (SCR Integrated Control System) to secure footprint and price competitiveness.

SCR Reactor



CI (Compact Injector)
- Mixer + Injector

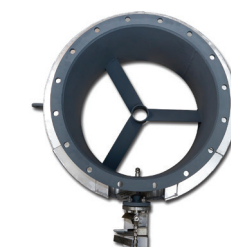

Control Panel



Integrated Dosing Unit



PanSIS
(Control Panel + Dosing Unit)





Exhaust Gas Cooler for WinGD iCER (Intelligent Control by Exhaust Recycling)

iCER (Intelligent Control by Exhaust Recycling) is aimed at minimizing emissions by regulating air and exhaust gas flow. By cooling and recirculating exhaust gas back to the engine, more emissions are combusted before they enter the atmosphere.

The benefits are impressive, with gas mode showing a reduction of at least 3% in energy consumption, diesel mode experiencing a 5% decrease in fuel consumption, and up to a 50% reduction in methane slip.

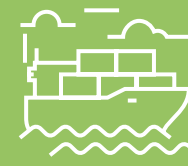
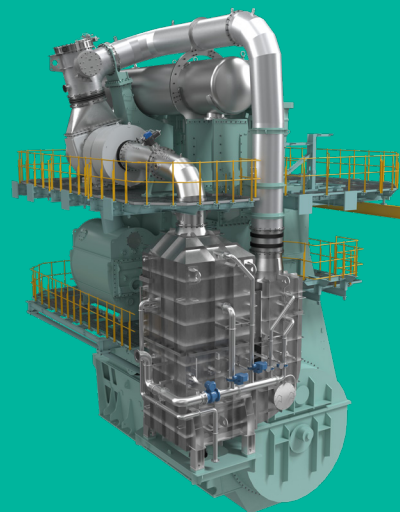

Water Treatment System (for EGR, for iCER)

WTS(Water Treatment System) is a treatment solution proposed to treat scrub water from the exhaust gas cleaning from ships.

The regulation on the quality of water during the discharge of exhaust gas recirculation (EGR) bleed-off water is defined in the IMO (International Maritime Organization) guidelines for EGR bleed-off water discharge, MEPC 307(73), and the following criteria are provided for the water quality of the discharge water.

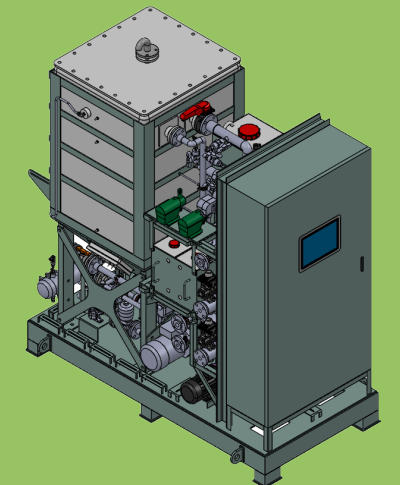

Wash water Discharge Criteria	
Discharge	Oil content of the bleed-off water
	< 15 ppm

System Overview

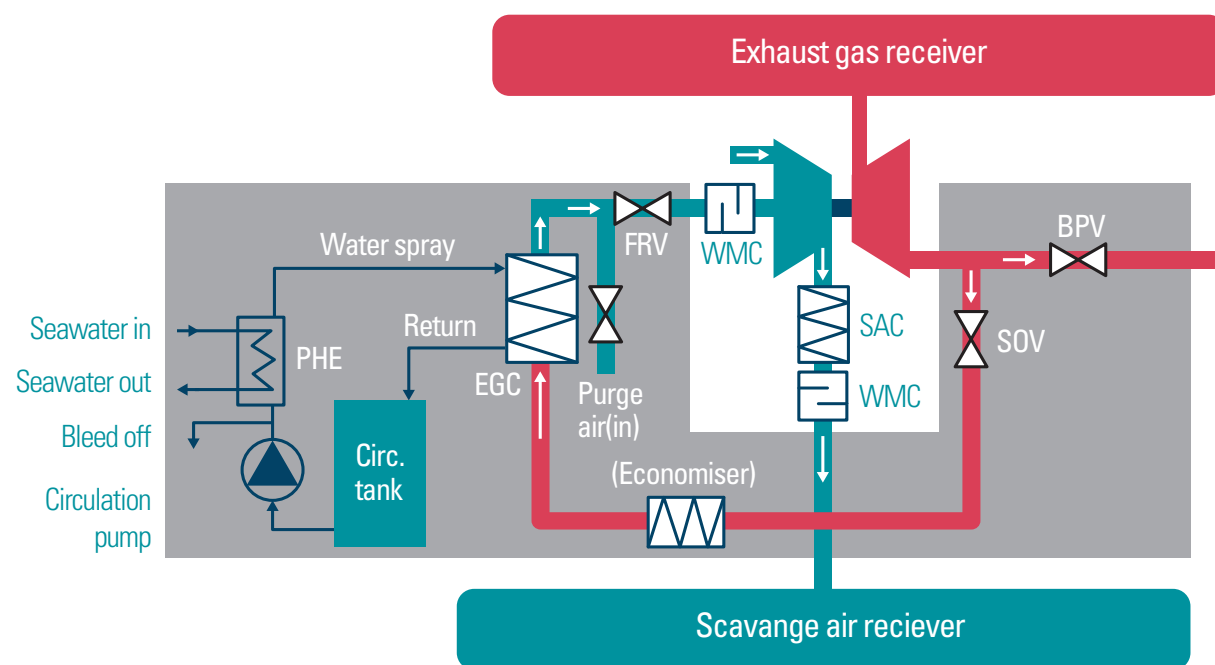

BPV	Back Pressure Valve	EGC	Exhaust Gas Cooler
SOV	Shut Off Valve	SAC	Scavange Air Cooler
EG	Exhaust Gas	WMC	Water Mist Catcher
PHE	Plate Heat Exchanger		

* Source : ADD MORE CERTAINTY TO YOUR FUTURE for WinGD

Composition

Treatment Capacity : 3 / 6 / 9 / 12 m³/h

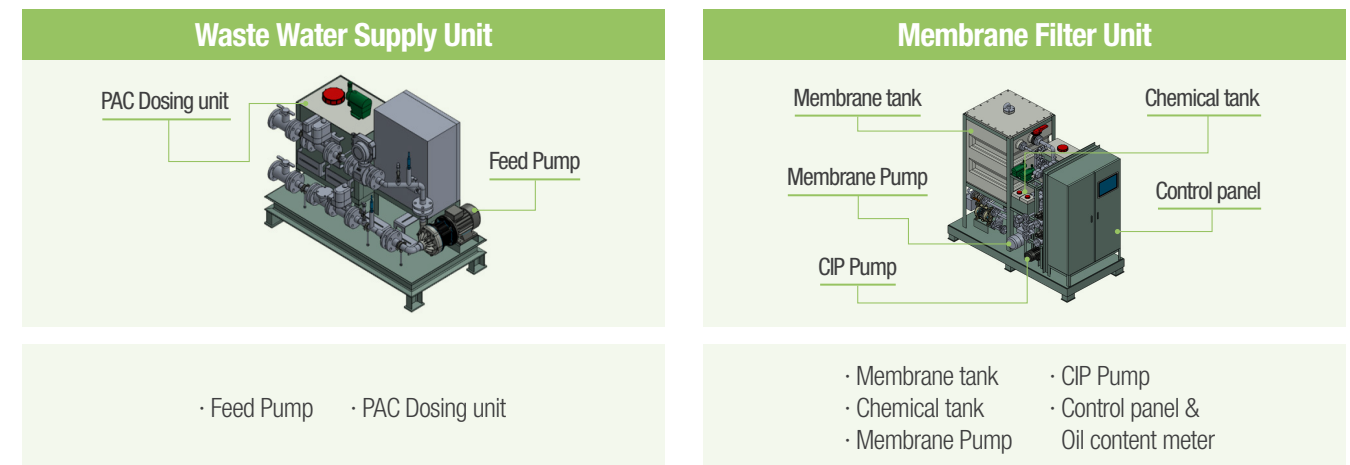

Water Treatment Method

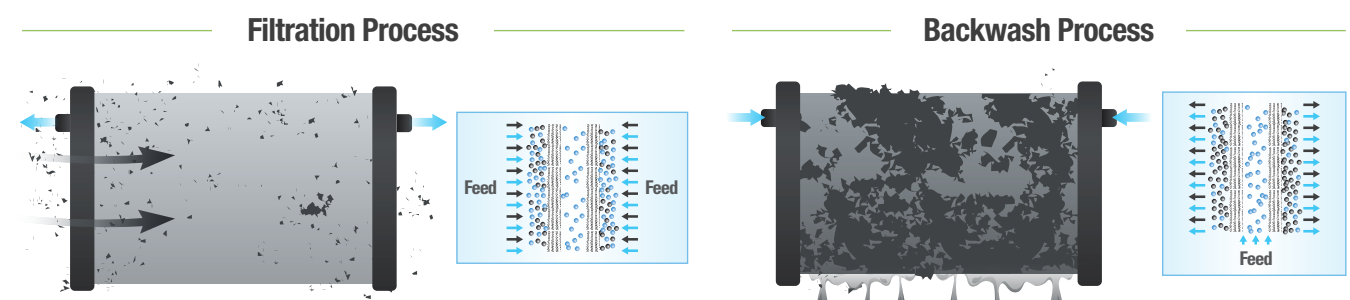

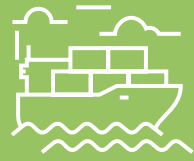

Water Treatment System

GloEn-Patrol™

PANASIA's water treatment system GloEn-Patrol™ is a water quality solution that is recognized as the most eco-friendly and safest system as it uses a filtration process, which is a 100% physical treatment method, and the "UV Lamp," which is UV disinfection technology.

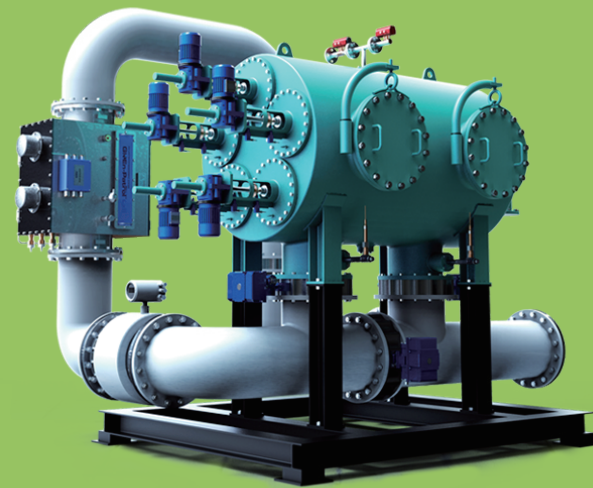

Product Line-up

GloEn-Patrol™ GI



Original Filter Unit
Original UV Unit

Combination

Treatment Capacity

Features

50~700 m³/hr

Small capacity with single unit

GloEn-Patrol™ GIII



MEGA Filter Unit
MEGA UV Unit

750~3,000 m³/hr

High efficiency in power consumption and footprint

Main Components

Original Filter Unit



MEGA Filter Unit

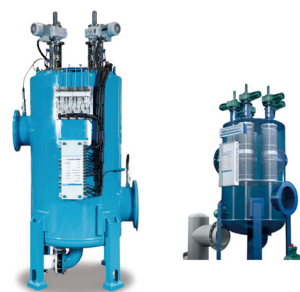

Original UV Unit

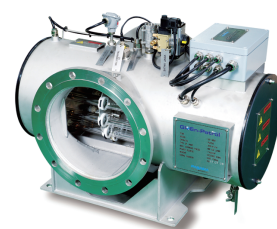

MEGA UV Unit

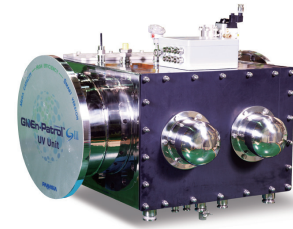

Measurement & Control System



Ships store and carry volatile substances like crude oil. All sorts of risks must be managed to ensure safety on ships and prevent marine pollution.

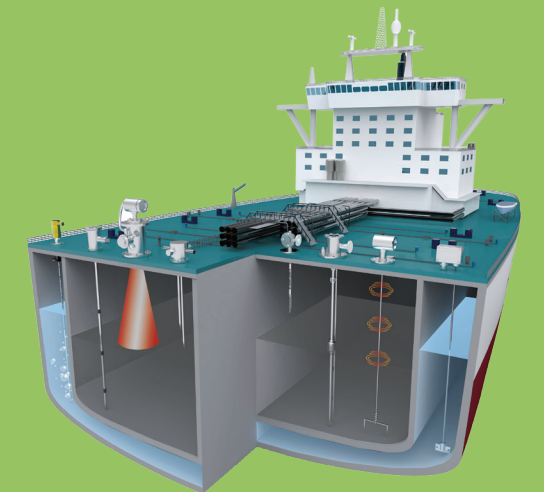

PANASIA's measurement control system monitors the levels of all sorts of critical components on board in real time. Using its alarm and analytics features, the system can also increase efficiency significantly in ensuring vessel safety and prevent marine pollution.

Product Line-up

01	02		
Cargo monitoring · Radar beam type · Magnetic float type	High & overfill alarm · Magnetic float type		
03	04	05	06
Tank level & draft gauging · Air purge type / Electric pneumatic type · Electric pressure type	Vapour emission control	Fixed gas detection	Water ingress alarm
07	08	09	10
Pressure / Temperature monitoring	Bilge high level alarm	Local level gauge / Switch	Pressure switch / Temperature sensor / Pressure transmitter

PANASIA SMART SERVICE puts our customers first

At PANASIA, we provide a smart service solution that allows us to treat customer satisfaction as a top priority, instead of just selling products. We offer unique services aimed at increasing customer convenience, from the MRO service for the maintenance, repairs, and efficient operation of products to our retrofit service using our advanced technology.



- Encompassing all processes, from system delivery to engineering, and to construction
- We provide the solutions best suited for customers' ships
- Wide-ranging technology consulting services
- Reliable partner in the retrofitting of existing ships
- Continuous maintenance/repairs, periodic follow-up services
- Advance inspection and diagnosis of consumables
- Product operation and training services
- Aiming to reduce costs and improve performance for customers



RETROFIT Service

PANASIA's Retrofit Service guarantees the best performance

PANASIA's tested and proven retrofitting service has been widely recognized in Korea and overseas for our top-notch technology and high service quality. We have the technological capabilities that we need to cover all processes, from equipment supply to engineering and construction. Also, among the engineering, installation, materials, and installation processes, you get to choose only those that require retrofitting.

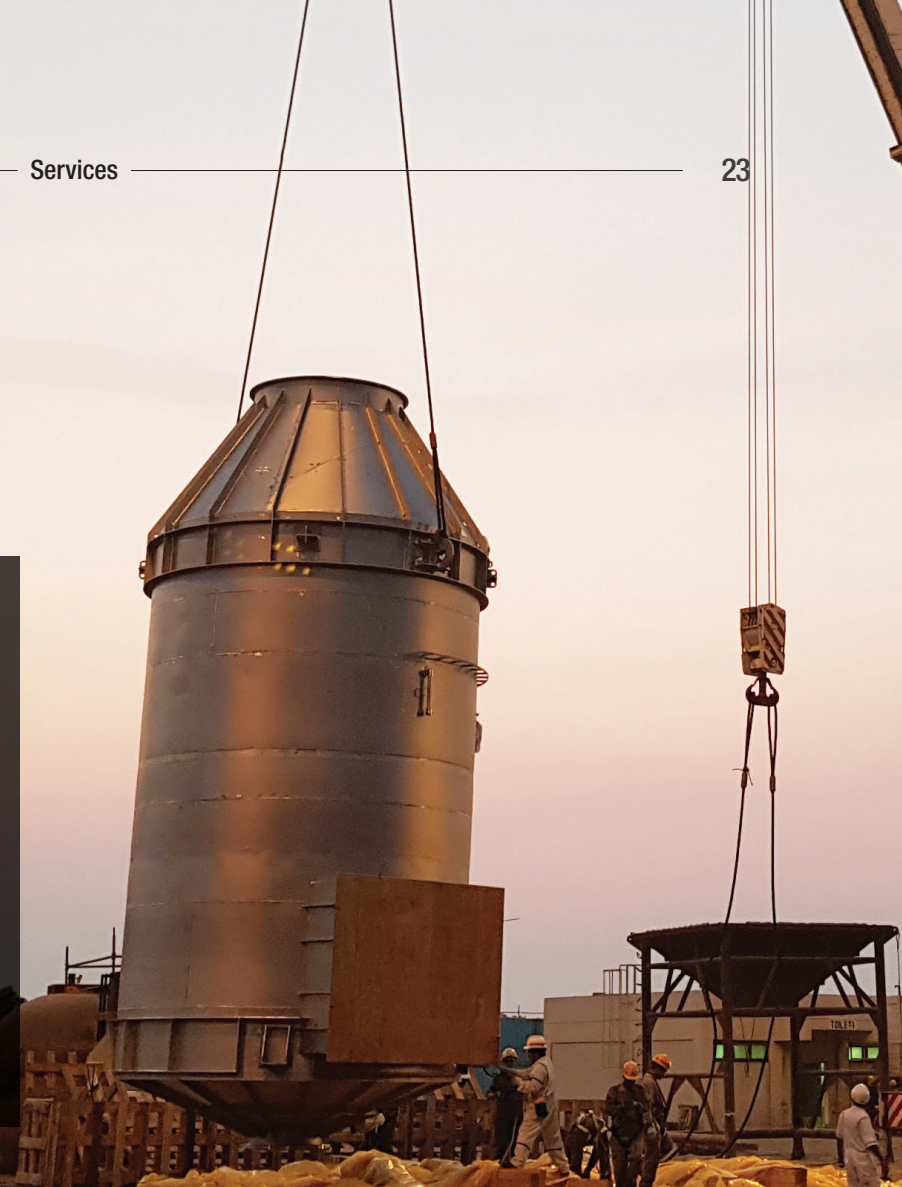

Our Services

You may determine the scope of work for installation on sea-going vessels

Equipment	Engineering	Design
<ul style="list-style-type: none"> · BWTS Equipment · SCRUBBER Equipment · Commissioning · Demonstration 	<ul style="list-style-type: none"> · Onboard Survey · Basic Design · Owner / Class Plan Approval · Interface with Existing Automation System 	<ul style="list-style-type: none"> · Installation Drawing · Manufacturing Drawing
Material Supply	Installation Work	Supervision
<ul style="list-style-type: none"> · Steel Structures · Pipe Spools · Installation Materials · Cables 	<ul style="list-style-type: none"> · Pipe Spools Installation · Laying & Connection Cables 	<ul style="list-style-type: none"> · Schedule Control · Quality Control · Instruction to Workers

Retrofit Contract Cases

4 Types of Contract Cases

CASE 1	System + Supervision
CASE 2	System + Engineering + Supervision
CASE 3	System + Engineering + Materials installed (piping, steel outfitting, electrical) + Supervision
CASE 4	System + Engineering + Materials installed (piping, steel outfitting, electrical) + Installation + Supervision

MRO Service Preventive Check-up Service & Calibration



Preventive Check-up Service & Calibration

Through PANASIA's MRO service, our engineers visit your ships periodically to perform checkups on the delivered products and proactively diagnose any potential issues in need of further inspection. Also, following the inspection, we prepare a report that contains any information and solutions you may need to ensure efficiency in your operations.

Through calibration, we conduct advance inspection for problems that may occur to make system operation as efficient as possible. Customers do not have to take care of every single one of the complicated sensors with many control points. They can also get maintenance/repair services scheduled immediately when it becomes necessary.

MRO Service Training Center & Engineer Training

At PANASIA, we operate Training Centers around the world. Through our learning program, we are training professional engineers on the regulatory requirements, which provide the background for making our products, on how to use our products, and how to respond when problems occur.

In addition, we organize annual field engineer training to provide highly satisfactory product training services.

Components of the Training Program

Chapter	Subject
1	Introduction of Company
2	Basic operating procedure
3	Maintenance requirement
4	Hands on practice (I)
5	Hands on practice (II)
6	Troubleshooting (I)
7	Troubleshooting (II & III)
8	Evaluation & Satisfaction Survey



MRO Service E-Learning Program

At PANASIA, we offer product training programs you can access anytime, anywhere. PANASIA's training program service called the "E-Learning Program" is available both online and on-site, allowing you access training anytime, anywhere. You can also watch videos and try running products on site using a tablet PC or a laptop. Our E-Learning Program contains product descriptions, operating instructions, crisis response, and other details so you can operate products professionally.



GloEn-Patrol™ Learning Program Contents

Chapter	Contents
1	Introduction of GloEn-Patrol™ system
2	Major system component
3	Standard operating procedures
4	Health and safety issue
5	Installation requirement
6	Maintenance requirement
7	Troubleshooting for Filter unit
8	Troubleshooting for UV unit
9	Troubleshooting for other components

PaSOx™ smart Learning Program Contents

Chapter	Contents
1	Understanding PaSOx™ scrubber system
2	Standard operating procedures
3	Compliance issues
4	Installation requirement
5	Maintenance requirement
6	Troubleshooting for the system/unit
7	Troubleshooting for the component/device

CBT (Computer Based Training Program)



IBT (Internet Based Training Program)

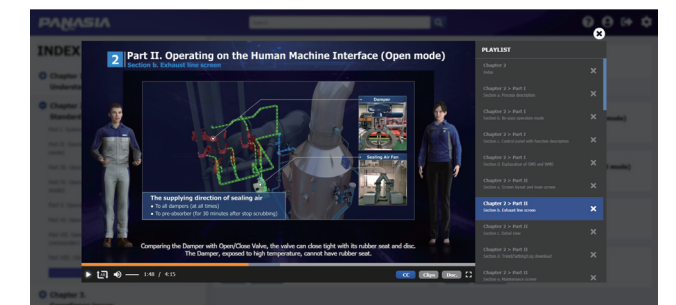

MRO Service Integrated Control System

PANASIA's integrated control system is a customized ICT-based service available 24/7, which collects product data in real time and checks the system status remotely to provide customers with prompt and accurate solutions anytime, anywhere.

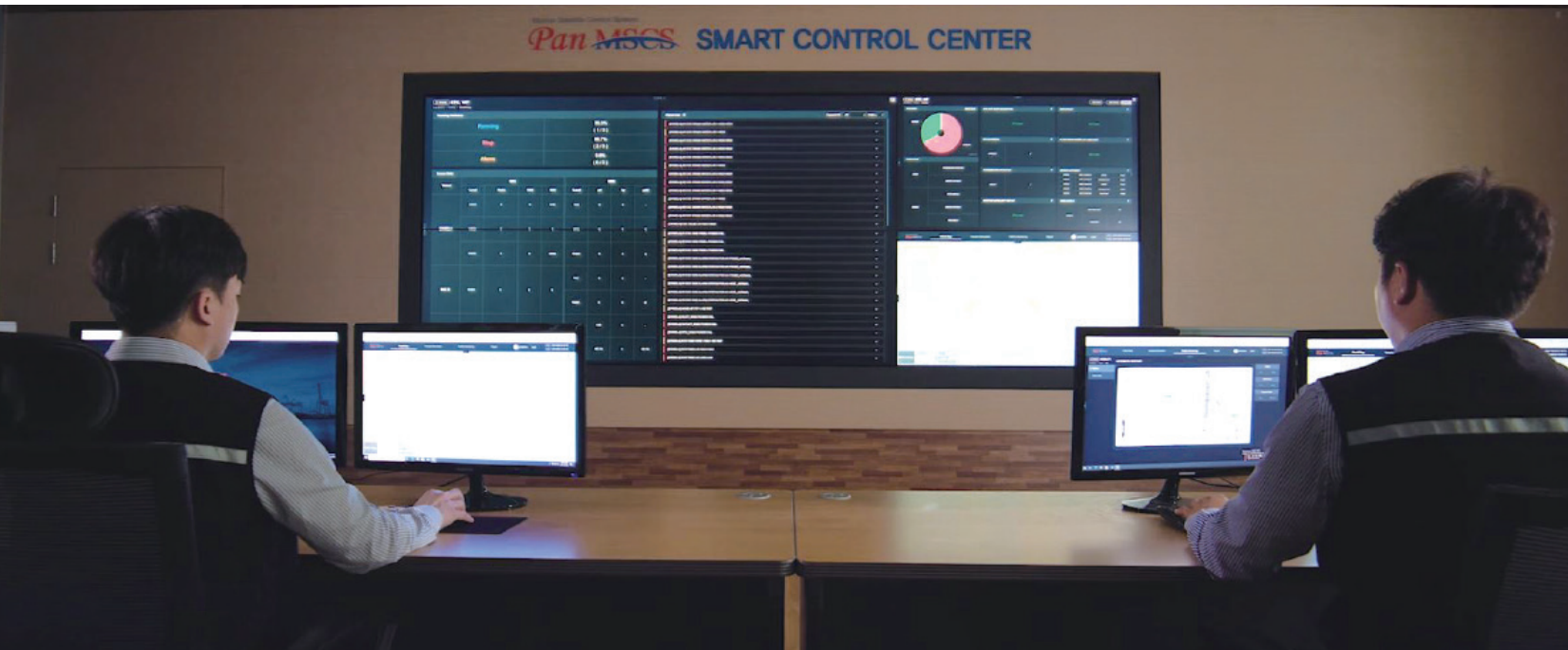

Pan-MSCS

Pan-MSCS is a Marine Satellite Control System. This solution monitors in real time, manages, and diagnoses the operating status of PANASIA's products (BWTS, Scrubber) installed on ships. If any problem occurs with any product, the system diagnoses the problem in advance, and notifies the ship of a solution to ensure safer operation.

Through big data analysis, it also notifies the ship of when to replace consumables, allowing the customer to operate the ship more efficiently. It helps us lead the way in creating a smart ship ecosystem.

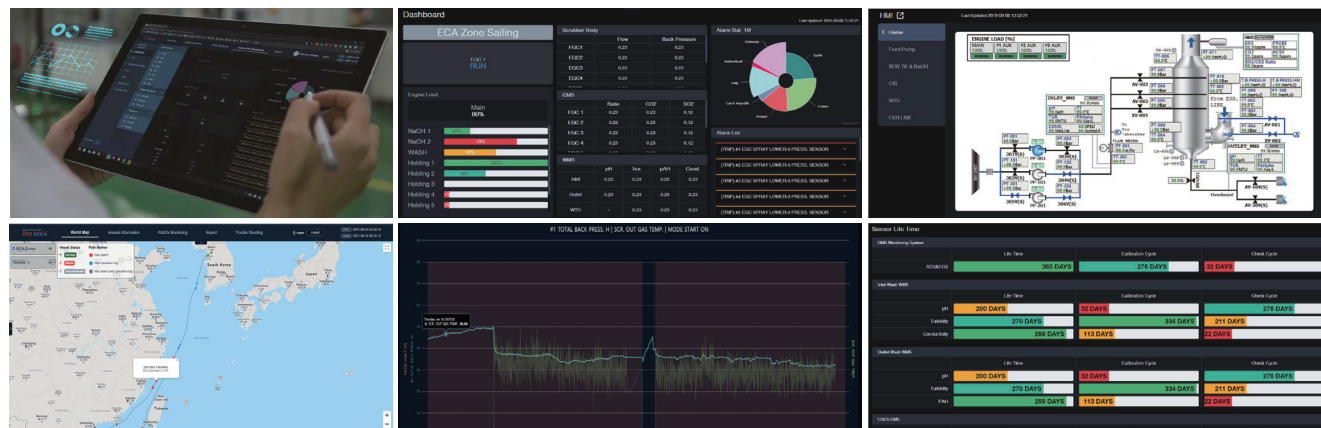

Global Network

47 Global Service Networks in 37 Countries



PANASIA Headquarter & 1st Factory



55, Mieumsandan 3-ro, Gangseo-gu Busan, South Korea (46744)

T +82-51-831-1010
F +82-51-831-1399
E panasia@worldpanasia.com

PANASIA 2nd Factory



98, Mieumgukje 3-ro, Gangseo-gu, Busan, South Korea (46747)

PANASIA 3rd Factory



350, Mieumsandanro, Gangseo-gu, Busan, South Korea (46747)

PANASIA CHINA Corp.



RM C-205, No.2080-50, Lianhua Rd, Shanghai, China (201103)

T +86-21-6235-1601~3
E china@worldpanasia.com

PANASIA JAPAN Corp.

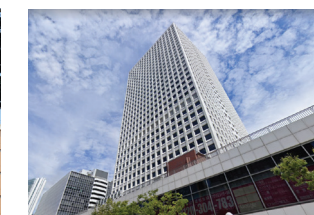

NO.600, Osaka Ekimae Dai.3 Building 6F, 1-1-3, Umeda, Kita-ku, Osaka, Japan (530-0001)

T +81-6-4795-8748
E japan@worldpanasia.com

PANASIA EUROPE B.V.



Rivium 3e Straat 25a, 2909 LH, Capelle aan den IJssel, Netherlands

T +31-10-79-53-005
E europe@worldpanasia.com

PANASIA EM



98, Mieumkukjae 3ro, Gangseo, Busan, Korea(46747)

T +82-70-4860-8075
F +82-70-4860-7984
E sh.han@worldpanasiaem.com
Contact. Mr. James Han



HEAD OFFICE & FACTORY 55, Mieumsandan3-ro, Gangseo-gu, Busan, 46744, Korea
TEL: +82-51-831-1010 FAX: +82-51-831-1399
www.worldpanasia.com E-mail: marketing@worldpanasia.com

CHINA CORPORATION RM C-205, No.2080-50, Lianhua Rd, Shanghai, China / Post Code : 201103
TEL: +86-21-6235-1601~3 E-mail: china@worldpanasia.com

JAPAN CORPORATION No.600, Osaka Ekimae Dai.3 Building 6F, 1-1-3, Umeda, Kita-ku, Osaka,
Japan / Post Code : 530-0001
TEL: +81-6-4795-8748 E-mail: japan@worldpanasia.com

EUROPE B.V. Rivium 3e Straat 25a, 2909 LH Capelle aan den IJssel, Netherlands
TEL: +31-10-79-53-005 E-mail: europe@worldpanasia.com



98, Mieumkukjae 3ro, Gangseo, Busan, 46747, Korea
TEL: +82-70-4860-8075 FAX : +82-70-4860-7984
E-mail : sh.han@worldpanasiaem.com



To reflect PANASIA's corporate philosophy of seeking eco-friendly and sustainable value,
this booklet was printed with naturally biodegradable soy ink that makes paper recycling easier.